

AMERICAN NATIONAL STANDARD

# **ANSI/ISA–88.01–1995**

Formerly ANSI/ISA–S88.01–1995

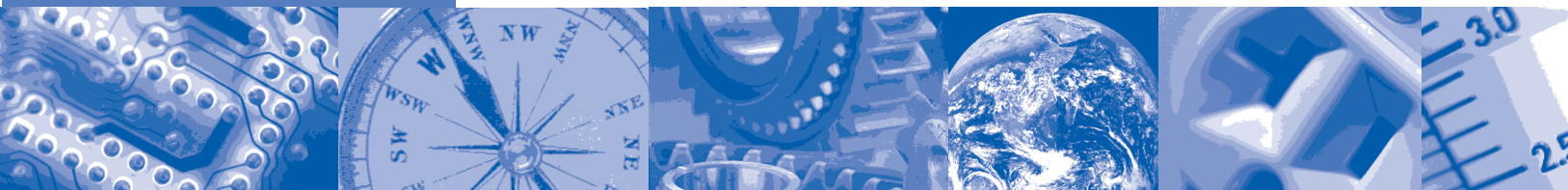

## **Batch Control Part 1: Models and Terminology**



**ISA—The Instrumentation,  
Systems, and  
Automation Society**

**Approved 23 October 1995**

ANSI/ISA-88.01-1995, Batch Control, Part 1: Models and Terminology

ISBN: 1-55617-562-0

Copyright © 1995 by the Instrument Society of America. All rights reserved. Printed in the United States of America. No part of this publication may be reproduced, stored in a retrieval system, or transmitted in any form or by any means (electronic, mechanical, photocopying, recording, or otherwise), without the prior written permission of the publisher.

ISA  
67 Alexander Drive  
P.O. Box 12277  
Research Triangle Park, North Carolina 27709

---

## Preface

---

This preface as well as all footnotes and annexes are included for informational purposes and are not part of ANSI/ISA-88.01-1995.

This standard has been prepared as part of the service of the ISA, the international society for measurement and control, toward a goal of uniformity in the field of instrumentation. To be of real value, this document should not be static but should be subject to periodic review. Toward this end, the Society welcomes all comments and criticisms and asks that they be addressed to the Secretary, Standards and Practices Board; ISA; 67 Alexander Drive; P. O. Box 12277; Research Triangle Park, NC 27709; Telephone (919) 990-9227; Fax (919) 549-8288; e-mail: standards@isa.org.

The ISA Standards and Practices Department is aware of the growing need for attention to the metric system of units in general, and the International System of Units (SI) in particular, in the preparation of instrumentation standards, recommended practices, and technical reports. The Department is further aware of the benefits to USA users of ISA standards of incorporating suitable references to the SI (and the metric system) in their business and professional dealings with other countries. Toward this end, this Department will endeavor to introduce SI-acceptable metric units in all new and revised standards to the greatest extent possible. *The Metric Practice Guide*, which has been published by the Institute of Electrical and Electronics Engineers as ANSI/IEEE Std. 268-1992, and future revisions, will be the reference guide for definitions, symbols, abbreviations, and conversion factors.

It is the policy of ISA to encourage and welcome the participation of all concerned individuals and interests in the development of ISA standards, recommended practices, and technical reports. Participation in the ISA standards-making process by an individual in no way constitutes endorsement by the employer of that individual, of ISA, or of any of the standards, recommended practices, and technical reports that ISA develops.

This standard is structured to follow the IEC guidelines. Therefore, the first three sections discuss the *Scope* of the standard, *Normative References*, and *Definitions*, in that order.

Section 4 is entitled *Batch Processes and Equipment*. The intent of this section is to discuss batch processing and the batch manufacturing plant. Things that are involved in batch manufacturing (e.g., batch process classification, equipment, and processes) are described in this section. The models and terminology defined in this section provide a foundation for understanding the application of batch control to the batch manufacturing plant in Sections 5 and 6.

Section 5 is entitled *Batch Control Concepts*. The intent of this section is to discuss key aspects of batch processing and batch manufacturing plants. This is where control is finally introduced to physical equipment, and the concept of equipment entities is introduced. Recipes are introduced in Section 5. The concepts of Allocation and Arbitration, Modes and States, and Exception Handling are introduced in this section so that they can be applied to the discussions in Section 6.

Section 6 is entitled *Batch Control Activities and Functions*. The intent of the models and terminology introduced in this section is to establish the necessary control activities that are needed to address the diverse control requirements of batch manufacturing. The concept of a Control Activity Model is introduced in this section. Each control activity from the Control Activity Model is discussed in terms of the individual control functions that are needed to address the batch processing, manufacturing, and control requirements of the previous two sections. Note

that there will be no attempt to define compliance requirements within this section since the overall purpose of this standard is to define a common approach to defining and modeling batch processes and their associated controls.

This standard (Part 1, Models and Terminology) is intended for people who are

- involved in designing and/or operating batch manufacturing plants;
- responsible for specifying controls and the associated application programs for batch manufacturing plants; or
- involved in the design and marketing of products in the area of batch control.

The following people served as active members of ISA Committee SP88:

<b>NAME</b>	<b>COMPANY</b>
L. Craig, Chairman	Rohm and Haas Company
*R. Mergen, Past Chairman	The Lubrizol Corporation
*T. Fisher, Past Chairman/Editor	The Lubrizol Corporation
C. Gross, Past Managing Director	Dow Chemical Company
*M. Albano	Honeywell, Inc.
A. Aujesky	ICI Australia Engineering
*J. Barrault	Siemens
G. Barron	John Brown Engineers & Constructors BV
R. Baxter	Eastman Kodak Company
*D. Brandl	Groupe Schneider
B. Braunstein	Exxon Chemical Company
*E. Bristol	The Foxboro Company
M. Bruns	Hoechst AG
R. Bullotta	WonderWare
*H. Burns	Fisher • Rosemount
G. Carlo-Stella	Batch Systems International
*B. Casey	Groupe Schneider
D. Chappell	Procter & Gamble Company
*L. Charpentier	GSE Process Solutions
*T. Crowl	Moore Products Company
*B. Cubizolles	Siemens
M. Dawson	Smith-Kline Beecham
*K. Dittman	Johnson Yokogawa
*D. Dodd	The Foxboro Company
*S. Duff	Moore Products Company
*C. Eaves	Intellution, Inc.
*D. Edwards	Johnson Yokogawa
*D. Emerson	GSE Process Solutions
*S. Farmer	ABB Process Automation, Inc.
G. Felton	Ashland Chemical
H. Fittler	Honeywell Regelsysteme
*A. Ghosh	The Foxboro Company
*P. Gustafson	Hartmann & Braun

---

\* One vote per company

<b>NAME</b>	<b>COMPANY</b>
* R. Hall	PID, Inc.
*W. Hawkins	Fisher • Rosemount
N. Haxthausen	Novo-Nordisk Engineering
*C. Hertz	Bailey Controls Company
S. Hjelmager	CRI Industrial Systems A/S
T. Hoekstra	Yokogawa Europe
*T. Hollowell	Fisher • Rosemount
*D. Hornbeck	Allen-Bradley Co.
*D. Imming	Fisher • Rosemount
*S. Jayanthi	Intellution, Inc.
*B. Jensen	Johnson Yokogawa
T. Jonsson	ABB Automation AB
H. Kayser	Consultant
G. Klipfel	Upjohn Company
*D. Leach	Air Products & Chemicals Company
T. Leffert	3M
*B. Lightle	Allen-Bradley Company
*W. Loner	Bailey Controls Company
R. Lotz	Consultant
B. Lozier	Pacific Access Computer
*D. Macias	Fisher • Rosemount
S. Mallaband	Bass Brewers, Ltd.
*E. Massey	Honeywell, Inc.
W. McFarlane	Valmet Automation, Inc.
*N. Meierhoefer	Hartmann & Braun
*T. Müller-Heinzerling	Siemens
L. Natiello	Kraft General Foods
K. Ng	Office of Naval Research
*P. Nowicki	ABB Process Automation, Inc.
A. Pampel	A. F. Pampel Consulting
*A. Pawlus	Honeywell, Inc.
*S. Prichard	Fisher • Rosemount
A. Rabinowitz	Consultant
H. Rosenof	Gensym Corporation
*J. Ruhe	Bailey Controls Company
P. Saebye	CRI Industrial Systems A/S
*M. Saucier	PID, Inc.
*C. Schmidt	Siemens
*J. Schwatmann	Siemens
J. Shaffer	Consultant
R. Shilts	Modicon AEG
E. Smith	Good Manufacturing Practices, Inc.
*K. Spencer	ABB Process Automation, Inc.
*J. Sten	E. I. du Pont de Nemours & Company (Ret.)
*F. Sutter	Fisher • Rosemount
*B. Sykes	Johnson Yokogawa
R. Thome	Merck
T. Tom	Elsag Bailey

---

\* One vote per company

**NAME****COMPANY**

J. Unger	Chesebrough-Pond's (Unilever)
*J. Vardy	The Foxboro Company
J. Verhulst	Biogen, Inc.
J. Via III	Alcon Labs
*N. Vroom	Honeywell, Inc.
*H. Wähler	Hartmann & Braun
*M. Warburton	ABB Process Automation, Inc.
R. Watson	Mettler-Toledo, Inc.
*A. Webster	E. I. du Pont de Nemours & Company
A. Weidenbach	Eastman Chemical Company
*S. Whitman	Johnson Yokogawa
*E. Whitmer	Honeywell, Inc.
*G. Wilcox	Air Products & Chemicals Company

This published standard was approved for publication by the ISA Standards and Practices Board in February 1995.

**NAME****COMPANY**

M. Widmeyer, Vice President	The Supply System
H. Baumann	H. D. Baumann & Associates, Ltd.
D. Bishop	Chevron USA Production Company
P. Brett	Honeywell, Inc.
W. Calder III	Foxboro Company
H. Dammeyer	The Ohio State University
R. Dieck	Pratt & Whitney
H. Hopkins	Utility Products of Arizona
A. Iverson	Lyondell Petrochemical Company
K. Lindner	Endress + Hauser GmbH + Company
T. McAviney	Metro Wastewater Reclamation District
A. McCauley, Jr.	Chagrin Valley Controls, Inc.
G. McFarland	Consultant
J. Mock	Consultant
E. Montgomery	Fluor Daniel, Inc.
D. Rapley	Rapley Engineering Services
R. Reimer	Allen-Bradley Company
R. Webb	Pacific Gas & Electric Company
W. Weidman	Consultant
J. Weiss	Electric Power Research Institute
J. Whetstone	National Institute of Standards & Technology
C. Williams	Eastman Kodak Company
G. Wood	Graeme Wood Consulting
M. Zielinski	Fisher • Rosemount

---

\* One vote per company

---

# Contents

---

<b>1</b>	<b>Scope</b>	<b>13</b>
<b>2</b>	<b>Normative references</b>	<b>13</b>
<b>3</b>	<b>Definitions</b>	<b>13</b>
<b>4</b>	<b>Batch processes and equipment</b>	<b>17</b>
4.1	Processes, batches, and batch processes	18
4.2	Physical model	20
4.3	Process cell classification	23
<b>5</b>	<b>Batch control concepts</b>	<b>27</b>
5.1	Structure for batch control	27
5.2	Equipment entities	30
5.3	Recipes	35
5.4	Production plans and schedules	51
5.5	Production information	52
5.6	Allocation and arbitration	54
5.7	Modes and states	55
5.8	Exception handling	61
<b>6</b>	<b>Batch control activities and functions</b>	<b>61</b>
6.1	Control activities	62
6.2	Recipe management	66
6.3	Production planning and scheduling	70
6.4	Production information management	70
6.5	Process management	76
6.6	Unit supervision	80
6.7	Process control	82
6.8	Personnel and environmental protection	84
<b>Annexes</b>		
A	(normative) Model philosophy	87
B	(informative) Bibliography	95

## Figures

1	— Process model (Entity - Relationship diagram)	19
2	— Physical model	21
3	— Single-path structure	24
4	— Multiple-path structure	25
5	— Network structure	26
6	— Procedural control model	28
7	— Procedural control/equipment mapping to achieve process functionality	31
8	— Recipe types	36
9	— General recipe procedure	40
10	— Master recipe procedure	41
11	— Procedural element relationships in the site recipe and master recipe	42
12	— Control recipe procedure/equipment control separation	44
13	— Control recipe procedure example with unit procedures, operations, and phases	46
14	— Control recipe procedure example with unit procedures and operations	47
15	— Control recipe procedure example with unit procedures	48
16	— Control recipe procedure example with only a procedure	49
17	— Control recipe procedure/equipment control collapsibility examples	50
18	— State transition diagram for example states for procedural elements	59
19	— Control activity model	63
20	— Simultaneous definition/selection of procedural elements and equipment entities	66
21	— Recipe management	67
22	— Process management	76
23	— Unit supervision	80
24	— Process control	83
A.1	— Basic and looped associations in Entity-Relationship diagrams	88
A.2	— Labeled associations in Entity-Relationship diagrams	89
A.3	— Process model (Entity-Relationship diagram)	90
A.4	— Process control (control activity with breakdown into control functions)	91
A.5	— State transition diagram	92
A.6	— Single-path structure (physical drawing)	92
A.7	— Site recipe procedure to master recipe procedure relationship (nesting model)	93

## Tables

1	— Possible implementations of example modes	57
2	— State transition matrix for example states for procedural elements	58



---

## Foreword

---

- 1) The formal decisions or agreements of the IEC on technical matters, prepared by technical committees on which all the National Committees having a special interest therein are represented, express, as nearly as possible, an international consensus of opinion on the subjects dealt with.
- 2) They have the form of recommendations for international use and they are accepted by the National Committees in that sense.
- 3) In order to promote international unification, the IEC expresses the wish that all National Committees should adopt the text of the IEC recommendation for their national rules insofar as national conditions will permit. Any divergence between the IEC recommendation and the corresponding national rules should, as far as possible, be clearly indicated in the latter.
- 4) The IEC has not laid down any procedure concerning marking as an indication of approval and has no responsibility when an item of equipment is declared to comply with one of its recommendations.

This part of this International Standard has been prepared by IEC/SC65A/WG11 and ISA SP88.

It forms part 1 of a series, the other part being Part 2: Data structures and guidelines for languages.

Annex A forms an integral part of this part of this international standard. Refer to Annex A for an explanation of the format and general associations used in creating the diagrams in this international standard. Annex B is for information only.



---

## Introduction

---

This part of this international standard on Batch Control provides standard models and terminology for defining the control requirements for batch manufacturing plants. The models and terminology defined in this standard

- emphasize good practices for the design and operation of batch manufacturing plants;
- can be used to improve control of batch manufacturing plants; and
- can be applied regardless of the degree of automation.

Specifically, this standard provides a standard terminology and a consistent set of concepts and models for batch manufacturing plants and batch control that will improve communications between all parties involved; and that will

- reduce the user's time to reach full production levels for new products;
- enable vendors to supply appropriate tools for implementing batch control;
- enable users to better identify their needs;
- make recipe development straightforward enough to be accomplished without the services of a control systems engineer;
- reduce the cost of automating batch processes; and
- reduce life-cycle engineering efforts.

It is not the intent of this standard to

- suggest that there is only one way to implement or apply batch control;
- force users to abandon their current way of dealing with their batch processes; or
- restrict development in the area of batch control.

The models presented in this standard are presumed to be complete as indicated. However, they may be collapsed and expanded as described below. The unit and the control module levels may not be omitted from the physical model. The master recipe and the control recipe may not be omitted from the recipe types model. Specific rules for collapsing and expanding these models are not covered in this standard.

- Collapsing: Elements in the models may be omitted as long as the model remains consistent, and the functions of the element removed are taken into account.
- Expanding: Elements may be added to the modules. When they are added between related elements, the integrity of the original relationship should be maintained.



---

## 1 Scope

---

This part of the standard on Batch Control defines reference models for batch control as used in the process industries and terminology that helps explain the relationships between these models and terms. This standard may not apply to all batch control applications.

---

## 2 Normative references

---

The following normative documents contain provisions, which through reference in this text, constitute provisions of this part of this standard. At the time of publication, the editions indicated were valid. All normative documents are subject to revision, and parties to agreements based on this part of this standard are encouraged to investigate the possibility of applying the most recent editions of the normative documents indicated below. Members of IEC and ISO maintain registers of currently valid normative documents.

IEC 848: 1988, *Preparation of function charts for control systems*

NOTE – Structures defined in IEC 848 may be useful in the definition of procedural control, and in particular in the definition of a phase.

IEC 902: 1987, *Industrial-process measurement and control — Terms and definitions*

NOTE – Definitions found in IEC 902 were used as a basis for definitions in this standard. Where necessary, the specific connotation of terms used in batch control were included as definitions in this standard.

---

## 3 Definitions

---

For the purposes of this part of this international standard, the following definitions apply.

**3.1 allocation:** A form of coordination control that assigns a resource to a batch or unit.

NOTE – An allocation can be for the entire resource or for portions of a resource.

**3.2 arbitration:** A form of coordination control that determines how a resource should be allocated when there are more requests for the resource than can be accommodated at one time.

**3.3 area:** A component of a batch manufacturing site that is identified by physical, geographical, or logical segmentation within the site.

NOTE – An area may contain process cells, units, equipment modules, and control modules.

**3.4 basic control:** Control that is dedicated to establishing and maintaining a specific state of equipment or process condition.

NOTE – Basic control may include regulatory control, interlocking, monitoring, exception handling, and discrete or sequential control.

**3.5 batch:** 1.) The material that is being produced or that has been produced by a single execution of a batch process. 2.) An entity that represents the production of a material at any point in the process.

NOTE – Batch means both the material made by and during the process and also an entity that represents the production of that material. Batch is used as an abstract contraction of the words "the production of a batch."

**3.6 batch control:** Control activities and control functions that provide a means to process finite quantities of input materials by subjecting them to an ordered set of processing activities over a finite period of time using one or more pieces of equipment.

**3.7 batch process:** A process that leads to the production of finite quantities of material by subjecting quantities of input materials to an ordered set of processing activities over a finite period of time using one or more pieces of equipment.

**3.8 batch schedule:** A list of batches to be produced in a specific process cell.

NOTE – The batch schedule typically contains such information as what is to be produced, how much is to be produced, when or in what order the batches are to be produced, and what equipment is to be used.

**3.9 common resource:** A resource that can provide services to more than one requester.

NOTE – Common resources are identified as either exclusive-use resources or shared-use resources (3.22 and 3.54).

**3.10 control module:** The lowest level grouping of equipment in the physical model that can carry out basic control.

NOTE – This term applies to both the physical equipment and the equipment entity.

**3.11 control recipe:** A type of recipe which, through its execution, defines the manufacture of a single batch of a specific product.

**3.12 coordination control:** A type of control that directs, initiates, and/or modifies the execution of procedural control and the utilization of equipment entities.

**3.13 enterprise:** An organization that coordinates the operation of one or more sites.

**3.14 equipment control:** The equipment-specific functionality that provides the actual control capability for an equipment entity, including procedural, basic, and coordination control, and that is not part of the recipe.

**3.15 equipment entity:** A collection of physical processing and control equipment and equipment control grouped together to perform a certain control function or set of control functions.

**3.16 equipment module:** A functional group of equipment that can carry out a finite number of specific minor processing activities.

#### NOTES

1 An equipment module is typically centered around a piece of process equipment (a weigh tank, a process heater, a scrubber, etc.). This term applies to both the physical equipment and the equipment entity.

2 Examples of minor process activities are dosing and weighing.

**3.17 equipment operation:** An operation that is part of equipment control.

**3.18 equipment phase:** A phase that is part of equipment control.

- 3.19 equipment procedure:** A procedure that is part of equipment control.
- 3.20 equipment unit procedure:** A unit procedure that is part of equipment control.
- 3.21 exception handling:** Those functions that deal with plant or process contingencies and other events which occur outside the normal or desired behavior of batch control.
- 3.22 exclusive-use resource:** A common resource that only one user can use at any given time.
- 3.23 formula:** A category of recipe information that includes process inputs, process parameters, and process outputs.
- 3.24 general recipe:** A type of recipe that expresses equipment and site independent processing requirements.
- 3.25 header:** Information about the purpose, source and version of the recipe such as recipe and product identification, creator, and issue date.
- 3.26 ID:** A unique identifier for batches, lots, operators, technicians, and raw materials.
- 3.27 line; train:** See definition for train.
- 3.28 lot:** A unique amount of material having a set of common traits.
- NOTE – Some examples of common traits are material source, the master recipe used to produce the material, and distinct physical properties.
- 3.29 master recipe:** A type of recipe that accounts for equipment capabilities and may include process cell-specific information.
- 3.30 mode:** The manner in which the transition of sequential functions are carried out within a procedural element or the accessibility for manipulating the states of equipment entities manually or by other types of control.
- 3.31 operation:** A procedural element defining an independent processing activity consisting of the algorithm necessary for the initiation, organization, and control of phases.
- 3.32 path; stream:** The order of equipment within a process cell that is used, or is expected to be used, in the production of a specific batch.
- 3.33 personnel and environmental protection:** The control activity that
- prevents events from occurring that would cause the process to react in a manner that would jeopardize personnel safety and/or harm the environment; and/or
  - takes additional measures, such as starting standby equipment, to prevent an abnormal condition from proceeding to a more undesirable state that would jeopardize personnel safety and/or harm the environment.
- 3.34 phase:** The lowest level of procedural element in the procedural control model.
- 3.35 procedural control:** Control that directs equipment-oriented actions to take place in an ordered sequence in order to carry out some process-oriented task.
- 3.36 procedural element:** A building block for procedural control that is defined by the procedural control model.

**3.37 procedure:** The strategy for carrying out a process.

NOTE – In general, it refers to the strategy for making a batch within a process cell. It may also refer to a process that does not result in the production of product, such as a clean-in-place procedure.

**3.38 process:** A sequence of chemical, physical, or biological activities for the conversion, transport, or storage of material or energy.

**3.39 process action:** Minor processing activities that are combined to make up a process operation.

NOTE – Process actions are the lowest level of processing activity within the process model.

**3.40 process cell:** A logical grouping of equipment that includes the equipment required for production of one or more batches. It defines the span of logical control of one set of process equipment within an area.

NOTE – This term applies to both the physical equipment and the equipment entity.

**3.41 process control:** The control activity that includes the control functions needed to provide sequential, regulatory, and discrete control and to gather and display data.

**3.42 process input:** The identification and quantity of a raw material or other resource required to make a product.

**3.43 process management:** The control activity that includes the control functions needed to manage batch production within a process cell.

**3.44 process operation:** A major processing activity that usually results in a chemical or physical change in the material being processed and that is defined without consideration of the actual target equipment configuration.

**3.45 process output:** An identification and quantity of material or energy expected to result from one execution of a control recipe.

**3.46 process parameter:** Information that is needed to manufacture a material but does not fall into the classification of process input or process output.

NOTE – Examples of process parameter information are temperature, pressure, and time.

**3.47 process stage:** A part of a process that usually operates independently from other process stages and that usually results in a planned sequence of chemical or physical changes in the material being processed.

**3.48 recipe:** The necessary set of information that uniquely defines the production requirements for a specific product.

NOTE – There are four types of recipes defined in this standard: general, site, master, and control.

**3.49 recipe management:** The control activity that includes the control functions needed to create, store, and maintain general, site, and master recipes.

**3.50 recipe operation:** An operation that is part of a recipe procedure in a master or control recipe.

**3.51 recipe phase:** A phase that is part of a recipe procedure in a master or control recipe.

**3.52 recipe procedure:** The part of a recipe that defines the strategy for producing a batch.



**3.53 recipe unit procedure:** A unit procedure that is part of a recipe procedure in a master or control recipe.

**3.54 shared-use resource:** A common resource that can be used by more than one user at a time.

**3.55 site:** A component of a batch manufacturing enterprise that is identified by physical, geographical, or logical segmentation within the enterprise.

NOTE – A site may contain areas, process cells, units, equipment modules, and control modules.

**3.56 site recipe:** A type of recipe that is site specific.

NOTE – Site recipes may be derived from general recipes recognizing local constraints, such as language and available raw materials.

**3.57 state:** The condition of an equipment entity or of a procedural element at a given time.

NOTE – The number of possible states and their names vary for equipment and for procedural elements.

**3.58 stream; path:** See definition for path.

**3.59 train; line:** A collection of one or more units and associated lower level equipment groupings that has the ability to be used to make a batch of material.

**3.60 unit:** A collection of associated control modules and/or equipment modules and other process equipment in which one or more major processing activities can be conducted.

#### NOTES

1 Units are presumed to operate on only one batch at a time. Units operate relatively independently of one another.

2 This term applies to both the physical equipment and the equipment entity.

3 Examples of major processing activities are react, crystallize, and make a solution.

**3.61 unit procedure:** A strategy for carrying out a contiguous process within a unit. It consists of contiguous operations and the algorithm necessary for the initiation, organization, and control of those operations.

**3.62 unit recipe:** The part of a control recipe that uniquely defines the contiguous production requirements for a unit.

NOTE – The unit recipe contains the unit procedure and its related formula, header, equipment requirements, and other information.

**3.63 unit supervision:** The control activity that includes control functions needed to supervise the unit and the unit's resources.

---

## 4 Batch processes and equipment

---

This section provides an overview of batch processing and the batch manufacturing plant. The models and terminology defined in this section provide a foundation for understanding the application of batch control to the batch manufacturing plant in Sections 5 and 6. Specifically, this section discusses batch processes, a physical model, and process cell classification.

## 4.1 Processes, batches, and batch processes

A process is a sequence of chemical, physical or biological activities for the conversion, transport or storage of material or energy. Industrial manufacturing processes can generally be classified as continuous, discrete parts manufacturing, or batch. How a process is classified depends on whether the output from the process appears in a continuous flow (continuous), in finite quantities of parts (discrete parts manufacturing), or in finite quantities of material (batches). Although aspects of this standard may apply to discrete parts manufacturing or continuous processes, this standard does not specifically address these types of processes.

### 4.1.1 Continuous processes

In a continuous process, materials are passed in a continuous flow through processing equipment. Once established in a steady operating state, the nature of the process is not dependent on the length of time of operation. Start-ups, transitions, and shutdowns do not usually contribute to achieving the desired processing.

### 4.1.2 Discrete parts manufacturing processes

In a discrete parts manufacturing process, products are classified into production lots that are based on common raw materials, production requirements, and production histories. In a discrete parts manufacturing process, a specified quantity of product moves as a unit (group of parts) between workstations, and each part maintains its unique identity.

### 4.1.3 Batch processes

The batch processes addressed in this standard lead to the production of finite quantities of material (batches) by subjecting quantities of input materials to a defined order of processing actions using one or more pieces of equipment. The product produced by a batch process is called a batch. Batch processes are discontinuous processes. Batch processes are neither discrete nor continuous; however, they have characteristics of both.

The subdivisions of a batch process can be organized in a hierarchical fashion as shown in [Figure 1](#). The example batch process used in this section is the production of polyvinyl chloride by the polymerization of vinyl chloride monomer.

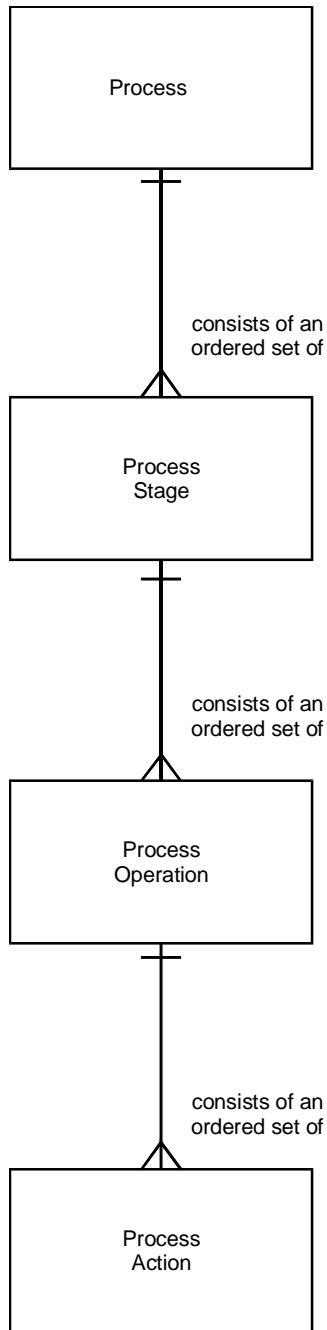

**Figure 1 — Process model (Entity - Relationship diagram)**

#### 4.1.3.1 Process stages

The process consists of one or more process stages which are organized as an ordered set, which can be serial, parallel, or both. A process stage is a part of a process that usually operates independently from other process stages. It usually results in a planned sequence of chemical or physical changes in the material being processed. Typical process stages in the polyvinyl chloride process might be the following:

- Polymerize: Polymerize vinyl chloride monomer into polyvinyl chloride.
- Recover: Recover residual vinyl chloride monomer.
- Dry: Dry polyvinyl chloride.

#### 4.1.3.2 Process operations

Each process stage consists of an ordered set of one or more process operations. Process operations represent major processing activities. A process operation usually results in a chemical or physical change in the material being processed. Typical process operations for the polymerization of vinyl chloride monomer into polyvinyl chloride process stage might be the following:

- Prepare reactor: Evacuate the reactor to remove oxygen.
- Charge: Add demineralized water and surfactants.
- React: Add vinyl chloride monomer and catalyst, heat to 55 - 60°C, and hold at this temperature until the reactor pressure decreases.

#### 4.1.3.3 Process actions

Each process operation can be subdivided into an ordered set of one or more process actions that carry out the processing required by the process operation. Process actions describe minor processing activities that are combined to make up a process operation. Typical process actions for the react process operation might be the following:

- Add: Add the required amount of catalyst to the reactor.
- Add: Add the required amount of vinyl chloride monomer to the reactor.
- Heat: Heat the reactor contents to 55 - 60°C.
- Hold: Hold the reactor contents at 55 - 60°C until the reactor pressure decreases.

## 4.2 Physical model

This section discusses a physical model that can be used to describe the physical assets of an enterprise in terms of enterprises, sites, areas, process cells, units, equipment modules, and control modules.

The physical assets of an enterprise involved in batch manufacturing are usually organized in a hierarchical fashion as described in [Figure 2](#). Lower level groupings are combined to form higher levels in the hierarchy. In some cases, a grouping within one level may be incorporated into another grouping at that same level.

The model has seven levels, starting at the top with an enterprise, a site, and an area. These three levels are frequently defined by business considerations and are not modeled further in this

document. The three higher levels are part of the model to properly identify the relationship of the lower level equipment to the manufacturing enterprise.

The lower four levels of this model refer to specific equipment types. An equipment type in [Figure 2](#) is a collection of physical processing and control equipment grouped together for a specific purpose. The lower levels in the model are specific to technically defined and bounded groupings of equipment. The four lower equipment levels (process cells, units, equipment modules, and control modules) are defined by engineering activities ([see 5.2.3 and 6.1.3](#)). During these engineering activities, the equipment at lower levels is grouped together to form a new higher level equipment grouping. This is done to simplify operation of that equipment by treating it as a single larger piece of equipment. Once created, the equipment cannot be split up except by re-engineering the equipment in that level.

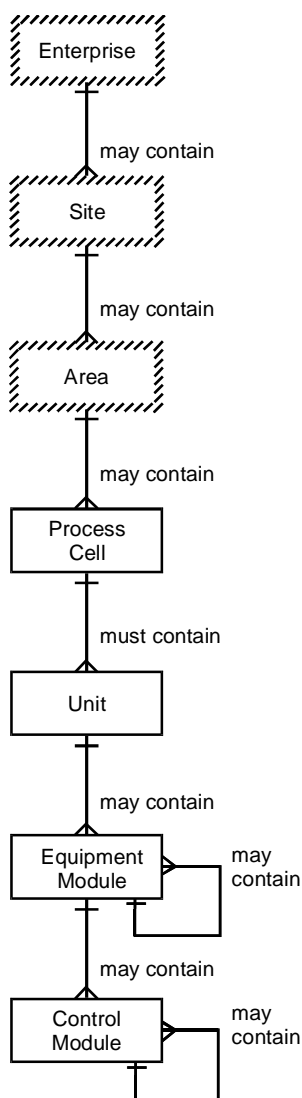

NOTE – The boxes for the top three levels are shown with slashed lines to indicate that the criteria that are used for configuring the boundaries of these three levels is often beyond the scope of batch control and this standard. Therefore, criteria for configuring the boundaries of these three levels of the physical model will not be discussed in this standard.

**Figure 2 — Physical model**

#### **4.2.1 Enterprise level**

An enterprise is a collection of one or more sites. It may contain sites, areas, process cells, units, equipment modules, and control modules.

The enterprise is responsible for determining what products will be manufactured, at which sites they will be manufactured, and in general how they will be manufactured.

There are many factors other than batch control that affect the boundaries of an enterprise. Therefore, the criteria for configuring the boundaries of an enterprise are not covered in this standard.

#### **4.2.2 Site level**

A site is a physical, geographical, or logical grouping determined by the enterprise. It may contain areas, process cells, units, equipment modules, and control modules.

The boundaries of a site are usually based on organizational or business criteria as opposed to technical criteria. There are many factors other than batch control that affect these boundaries. Therefore, the criteria for configuring the boundaries of a site are not covered in this standard.

#### **4.2.3 Area level**

An area is a physical, geographical, or logical grouping determined by the site. It may contain process cells, units, equipment modules, and control modules.

The boundaries of an area are usually based on organizational or business criteria as opposed to technical criteria. There are many factors other than batch control that affect these boundaries. Therefore, the criteria for configuring the boundaries of an area are not covered in this standard.

#### **4.2.4 Process cell level**

A process cell contains all of the units, equipment modules, and control modules required to make one or more batches.

Process control activities must respond to a combination of control requirements using a variety of methods and techniques. Requirements that cause physical control actions may include responses to process conditions or to comply with administrative requirements.

A frequently recognized subdivision of a process cell is the train. A train is composed of all units and other equipment that may be utilized by a specific batch. A batch does not always use all the equipment in a train. Furthermore, more than one batch and more than one product may use a train simultaneously. The order of equipment actually used or expected to be used by a batch is called the path. Although a process cell may contain more than one train, no train may contain equipment outside the boundaries of the process cell.

A process cell is a logical grouping of equipment that includes the equipment required for production of one or more batches. It defines the span of logical control of one set of process equipment within an area. The existence of the process cell allows for production scheduling on a process cell basis, and also allows for process cell-wide control strategies to be designed. These process cell-wide control strategies might be particularly useful in emergency situations.

#### **4.2.5 Unit level**

A unit is made up of equipment modules and control modules. The modules that make up the unit may be configured as part of the unit or may be acquired temporarily to carry out specific tasks.

One or more major processing activities — such as react, crystallize, and make a solution — can be conducted in a unit. It combines all necessary physical processing and control equipment

required to perform those activities as an independent equipment grouping. It is usually centered on a major piece of processing equipment, such as a mixing tank or reactor. Physically, it includes or can acquire the services of all logically related equipment necessary to complete the major processing task(s) required of it. Units operate relatively independently of each other.

A unit frequently contains or operates on a complete batch of material at some point in the processing sequence of that batch. However, in other circumstances it may contain or operate on only a portion of a batch. This standard presumes that the unit does not operate on more than one batch at the same time.

#### **4.2.6 Equipment module level**

Physically, the equipment module may be made up of control modules and subordinate equipment modules. An equipment module may be part of a unit or a stand-alone equipment grouping within a process cell. If engineered as a stand-alone equipment grouping, it can be an exclusive-use resource or a shared-use resource.

An equipment module can carry out a finite number of specific minor processing activities such as dosing and weighing. It combines all necessary physical processing and control equipment required to perform those activities. It is usually centered on a piece of processing equipment, such as a filter. Functionally, the scope of the equipment module is defined by the finite tasks it is designed to carry out.

#### **4.2.7 Control module level**

A control module is typically a collection of sensors, actuators, other control modules, and associated processing equipment that, from the point of view of control, is operated as a single entity. A control module can also be made up of other control modules. For example, a header control module could be defined as a combination of several on/off automatic block valve control modules.

Some examples of control modules are

- a regulating device consisting of a transmitter, a controller, and a control valve that is operated via the set point of the device;
- a state-oriented device that consists of an on/off automatic block valve with position feedback switches, that is operated via the set point of the device; or
- a header that contains several on/off automatic block valves and that coordinates the valves to direct flow to one or several destinations based upon the set point directed to the header control module.

### **4.3 Process cell classification**

This section discusses the classification of process cells by the number of different products manufactured in the process cell and by the physical structure of the equipment used in the manufacturing.

#### **4.3.1 Classification by number of products**

A process cell is classified as single-product or multi-product based on the number of products planned for production in that process cell.

A *single product* process cell produces the same product in each batch. Variations in procedures and parameters are possible. For example, variations may occur in order to compensate for

differences in equipment, to compensate for substitute raw materials, to compensate for changes in environmental conditions, or to optimize the process.

A *multi-product* process cell produces different products utilizing different methods of production or control. There are two possibilities:

- All products are produced with the same procedure using different formula values (varying materials and/or process parameters).
- The products are produced using different procedures.

#### 4.3.2 Classification by physical structure

The basic types of physical structures discussed here are *single path*, *multiple path*, and *network*.

A single-path structure is a group of units through which a batch passes sequentially (see [Figure 3](#)). A single-path structure could be a single unit, such as a reactor, or several units in sequence. Multiple input materials are typically used; multiple finished materials may be generated. Several batches may be in progress at the same time.

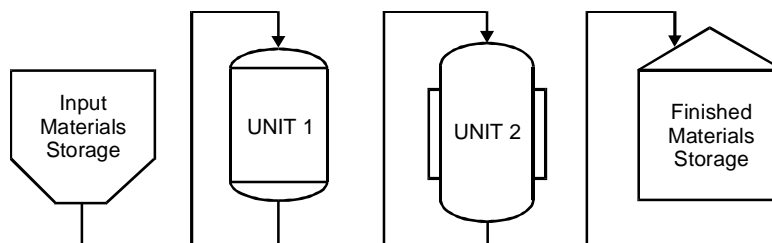

**Figure 3 — Single-path structure**



A *multiple-path* structure is shown in [Figure 4](#). It consists of multiple single-path structures in parallel with no product transfer between them. The units may share raw material sources and product storage. Several batches may be in progress at the same time. Although units within a multi-path structure may be physically similar, it is possible to have paths and units within a multi-path structure that are of radically different physical design.

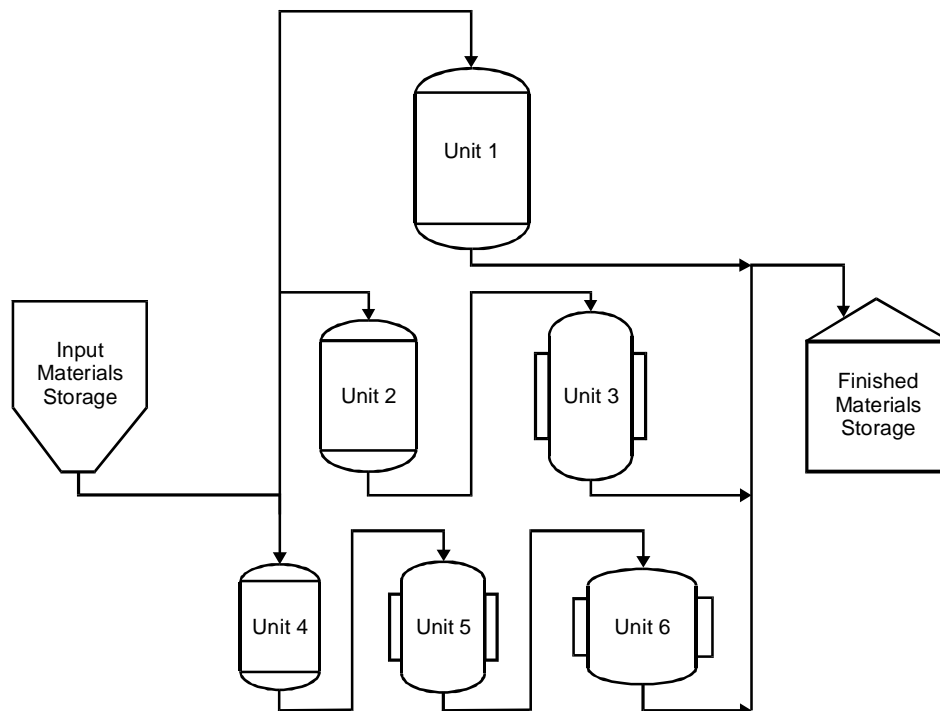

**Figure 4 — Multiple-path structure**

A *network* structure is shown in Figure 5. The paths may be either fixed or variable. When the paths are fixed, the same units are used in the same sequence. When the path is variable, the sequence may be determined at the beginning of the batch or it may be determined as the batch is being produced. The path could also be totally flexible. For example, a batch would not have to start at either Unit 1 or Unit 3; it could start with any unit and take multiple paths through the process cell. The units themselves may be portable within the process cell. In this case, verification of the process connections may be an important part of the procedures. Note that several batches may be in production at the same time. The units may share raw material sources and product storage.

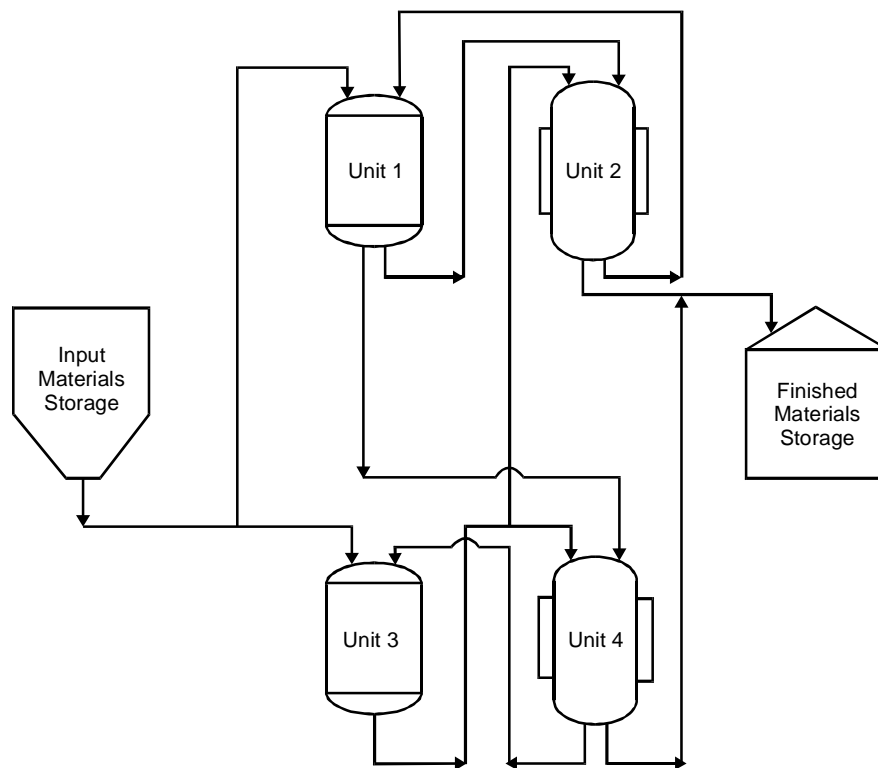

**Figure 5 — Network structure**

---

## 5 Batch control concepts

---

This section discusses the batch control concepts needed to address the batch processing/batch manufacturing needs presented in the preceding section and to define a consistent way of operating a batch manufacturing plant. A structure for batch control is discussed that introduces three types of control needed for batch manufacturing. When these control types are applied to equipment, the resulting equipment entities provide process functionality and control capability.

The concept of recipes is discussed, including the four types of recipes described in this standard and the contents of these recipes (in terms of the information categories used to describe a recipe). A relationship is established between the procedure in a recipe and the control associated with specific equipment entities (equipment control). The concept of collapsibility of the recipe procedure and of equipment control is discussed. Recipe transportability criteria are introduced for the four types of recipes.

Production plans and schedules, reference information, production information, allocation and arbitration, modes and states, and exception handling are other batch control concepts discussed in this section.

The intent of the models and terminology introduced in this section is to establish the necessary batch control understanding so that the control functions that are needed to address the diverse control requirements of batch manufacturing can be discussed in Section 6.

### 5.1 Structure for batch control

Section 4 introduced a physical model that defined terms for the hierarchy of equipment typically found in a batch manufacturing environment. This section describes the three types of control (basic control, procedural control, and coordination control) typically needed in batch manufacturing.

#### 5.1.1 Basic control

Basic control comprises the control dedicated to establishing and maintaining a specific state of equipment and process. Basic control

- includes regulatory control, interlocking, monitoring, exception handling, and repetitive discrete or sequential control;
- may respond to process conditions that could influence the control outputs or trigger corrective actions;
- may be activated, deactivated, or modified by operator commands or by procedural or coordination control.

Basic control in a batch environment is in principle no different from the control of continuous processes. However, in the batch environment, there may be higher requirements on the ability for basic control to receive commands and to modify its behavior based on these commands.

#### 5.1.2 Procedural control

Procedural control directs equipment-oriented actions to take place in an ordered sequence in order to carry out a process-oriented task.

Procedural control is a characteristic of batch processes. It is the control that enables equipment to perform a batch process.

Procedural control is made up of procedural elements that are combined in a hierarchical manner to accomplish the task of a complete process as defined by the process model. The hierarchy of identified and named procedural elements is illustrated in [Figure 6](#) and consists of procedures, unit procedures, operations, and phases.

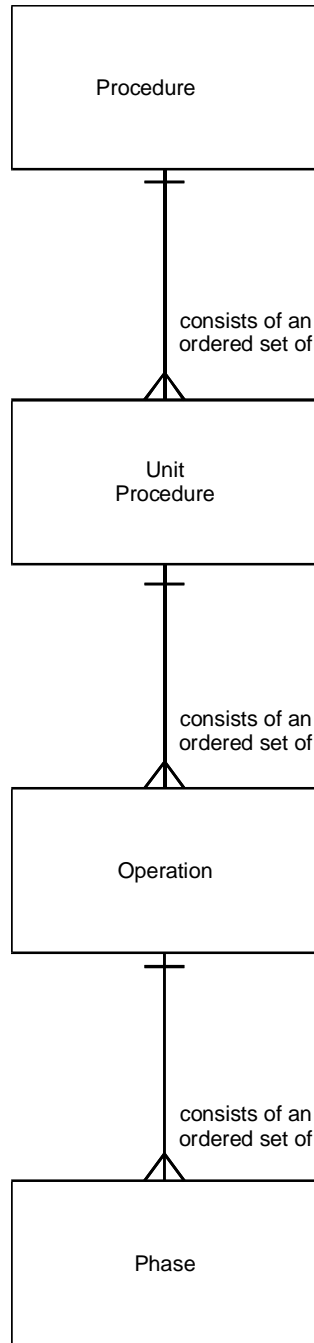

**Figure 6 — Procedural control model**

### 5.1.2.1 Procedure

The procedure is the highest level in the hierarchy and defines the strategy for carrying out a major processing action such as making a batch. It is defined in terms of an ordered set of unit procedures. An example of a procedure is "Make PVC."

### 5.1.2.2 Unit procedure

A unit procedure consists of an ordered set of operations that causes a contiguous production sequence to take place within a unit. Only one operation is presumed to be active in a unit at any time. An operation is carried to completion in a single unit. However, multiple unit procedures of one procedure may run concurrently, each in different units. Examples of unit procedures include the following:

- Polymerize VCM.
- Recover residual VCM.
- Dry PVC.

### 5.1.2.3 Operation

An operation is an ordered set of phases that defines a major processing sequence that takes the material being processed from one state to another, usually involving a chemical or physical change. It is often desirable to locate operation boundaries at points in the procedure where normal processing can safely be suspended.

Examples of operations include the following:

- Preparation: Pull a vacuum on the reactor and coat the walls with antifoulant.
- Charge: Add demineralized water and surfactants.
- React: Add VCM and catalyst, heat, and wait for the reactor pressure to drop.

### 5.1.2.4 Phase

The smallest element of procedural control that can accomplish a process-oriented task is a phase. A phase may be subdivided into smaller parts. The steps and transitions as described in IEC 848: 1988 document one method of defining subdivisions of a phase.

A phase can issue one or more commands or cause one or more actions, such as

- Enabling and disabling regulating and state-oriented types of basic control and specifying their set points and initial output values
- Setting, clearing, and changing alarm and other limits
- Setting and changing controller constants, controller modes, and types of algorithms
- Reading process variables, such as the gas density, gas temperature, and volumetric flow rate from a flowmeter, and calculating the mass flow rate through the flowmeter
- Conducting operator authorization checks.

The execution of a phase may result in

- commands to basic control;
- commands to other phases (either in the same or another equipment entity); and/or
- the collection of data.

The intent of the phase is to cause or define a process-oriented action, while the logic or set of steps that make up a phase are equipment specific. Examples of phases include the following:

- Add VCM.
- Add catalyst.
- Heat.

### **5.1.3 Coordination control**

Coordination control directs, initiates, and/or modifies the execution of procedural control and the utilization of equipment entities. It is time varying in nature, like procedural control, but it is not structured along a specific process-oriented task.

Examples of coordination control are algorithms for

- supervising availability or capacity of equipment;
- allocating equipment to batches;
- arbitrating requests for allocation;
- coordinating common resource equipment;
- selecting procedural elements to be executed;
- propagating modes.

The control functions that are needed to implement coordination control are discussed in more detail in Section 6 under the topic of control activities.

## **5.2 Equipment entities**

This section discusses equipment entities that are formed from the combination of equipment control and physical equipment. This combination results in four equipment entities: process cells, units, equipment modules, and control modules. Guidelines for structuring these equipment entities are also discussed.

When the terms process cell, unit, equipment module, and control module are used, they generally refer to the equipment and its associated equipment control. Whether equipment control in an equipment entity is implemented manually or by way of automation, it is only through the exercise of equipment control that the equipment can produce a batch.

The notion of equipment control being part of an equipment entity is to be understood logically. It is not a statement of the physical implementation of equipment control. However, it must be possible to identify equipment control for a particular equipment entity.

This interaction of equipment control and physical equipment is described purposely without any reference to language or implementation. The intent is to describe a framework within which equipment control and physical equipment may be defined and discussed.

### **5.2.1 Procedural control model/physical model/process model relationship**

The general relationship between the procedural control model, the physical model, and the process model is illustrated in [Figure 7](#). This mapping of procedural control with individual equipment provides processing functionality described in the process model.

The concept of equipment capabilities and usage of these capabilities to accomplish processing tasks is a major point of this standard. The procedural control capability of equipment entities is the mechanism that enables this. The procedural control may be entirely defined as part of equipment control, or it may be based on procedural information passed on to the equipment entity from the recipe.

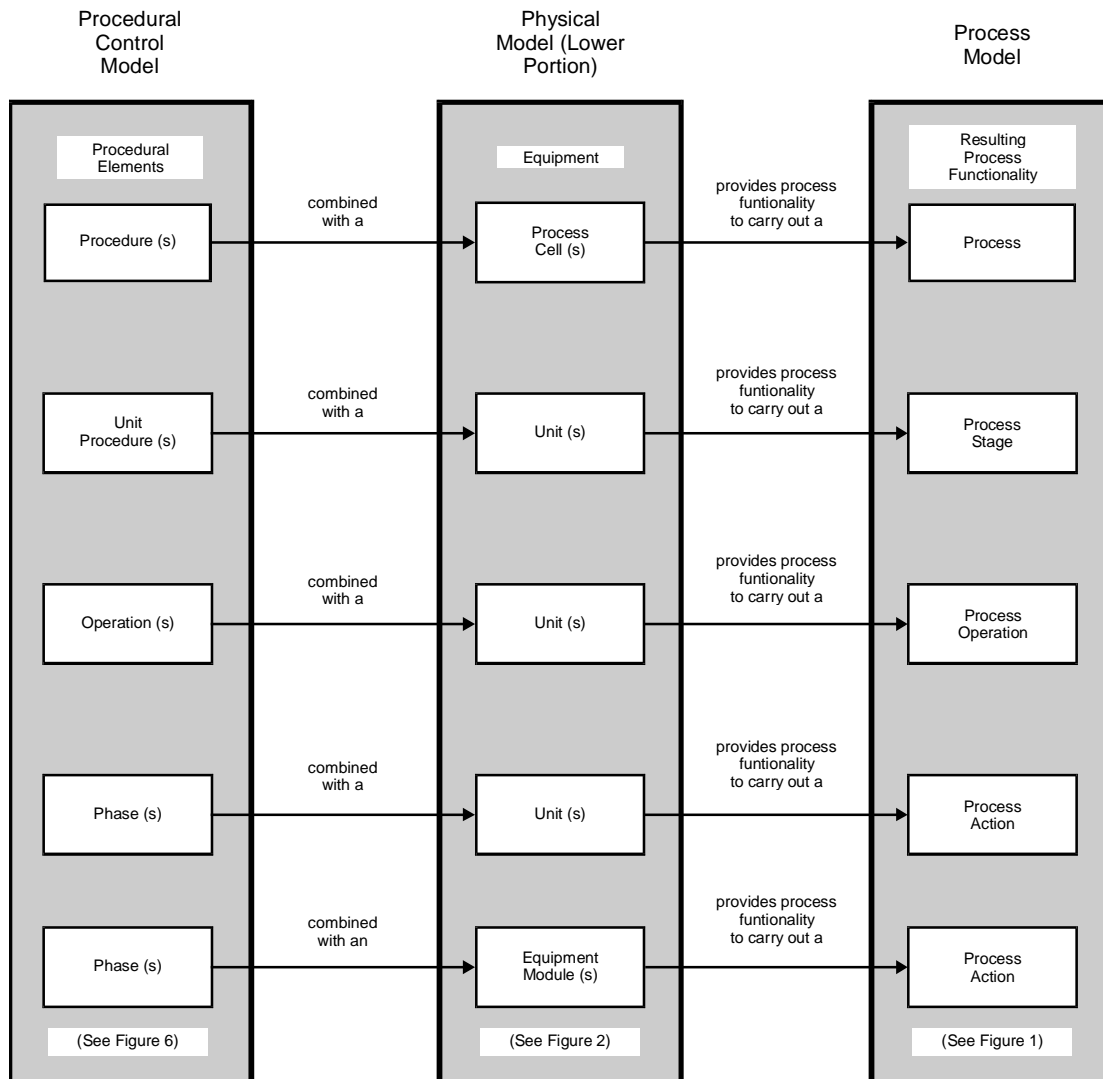

**Figure 7 — Procedural control/equipment mapping to achieve process functionality**

## **5.2.2 Equipment control in equipment entities**

The control capability possible in the different equipment entities are important characteristics and a main basis for classification of equipment entities. In the following paragraphs equipment control for the individual equipment entities is discussed.

### **5.2.2.1 Process cell**

The process cell is capable of orchestrating all processing activities for one or more batches. It receives recipes containing procedure, parameter, and other information and a schedule containing operational requirements for each batch. It may also need to prepare and monitor equipment or resources not currently involved in batch processing, such as which units are available, what units and piping are going through a clean-in-place (CIP) routine, and what the current inventories of raw materials are.

The complexity of control within the process cell will depend on the equipment available within the process cell, the interconnectivity among this equipment, the degree of freedom of movements of batches through this equipment, and the arbitration of the use of this equipment so that the equipment can be used most effectively.

Equipment control in the process cell may be distributed in the same manner as the physical equipment is subdivided. For example, if the process cell is subdivided into trains, equipment control within the process cell may be distributed among the various trains.

Equipment modules and control modules may exist as separate entities under direct control of the process cell.

#### **5.2.2.1.1 Basic control in process cells**

The process cell may include basic control that spans several units. For example, an interlock that shuts one unit down may need to be propagated to the upstream units that are feeding this particular unit.

#### **5.2.2.1.2 Procedural control in process cells**

The execution of a procedure and initiation of the individual unit procedures is a process cell responsibility. The execution may or may not be integral to the coordination control involved with the movement of batches as described in 5.2.2.1.3.

#### **5.2.2.1.3 Coordination control in process cells**

More coordination control is needed in process cells than in the lower level equipment entities because

- the process cell may contain multiple units and process multiple batches at the same time. This involves coordinating the execution of a number of different procedures;
- the control of the movement of batches may involve a number of choices between alternate paths. Although these choices may be made via links between units, the process cell may also have to determine the routing;
- arbitration may be needed at the process cell level to optimize the use of resources, such as shared resources and resources that must be reserved well in advance of the time actually needed.

Examples of coordination control in a process cell include algorithms that

- manage the initialization and movement of the batches being processed within the process cell; and



- initiate and/or associate unit procedures, parameters and other information in individual units in the proper order to cause them to process the product described by the unique combination of schedules and recipes.

### **5.2.2.2 Unit**

Units coordinate the functions of the lower level entities, such as equipment modules and control modules. The primary purpose of equipment control in a unit is to control the processing of the batch that is currently associated with the unit.

#### **5.2.2.2.1 Basic control in units**

Basic control in a unit is generally performed by regulatory control and discrete control in equipment modules and control modules within the unit.

#### **5.2.2.2.2 Procedural control in units**

Units may include and execute equipment phases, equipment operations, and equipment unit procedures or they may execute recipe operations and recipe unit procedures passed on to it.

#### **5.2.2.2.3 Coordination control in units**

Equipment control in a unit will include a substantially higher level of coordination control than any of the lower level equipment entities. This may include, for example, algorithms that manage unit and acquired resources; arbitrate requests for services from other units or from the process cell; acquire the services of resources from outside the unit; and communicate with other equipment entities outside unit boundaries.

### **5.2.2.3 Equipment module**

The primary purpose of equipment control in an equipment module is to coordinate the functions of other equipment modules and lower level control modules. An equipment module may be commanded by a process cell, a unit, an operator, or, in some cases, another equipment module.

#### **5.2.2.3.1 Basic control in equipment modules**

Basic control in an equipment module is generally performed by regulatory control and discrete control in control modules within the equipment module.

#### **5.2.2.3.2 Procedural control in equipment modules**

Equipment modules may execute equipment phases, but they do not have the capability of executing higher level procedural elements.

#### **5.2.2.3.3 Coordination control in equipment modules**

Coordination control in an equipment module includes coordination of its component parts and may include algorithms for propagating modes and for arbitrating requests from units.

### **5.2.2.4 Control module**

Equipment control normally found at this level directly manipulates actuators and other control modules. A control module can direct commands to other control modules and to actuators if they have been configured as part of the control module. Control of the process is effected through the equipment specific manipulation of control modules and actuators.

Examples of equipment control in control modules include

- opening or closing a valve, with confirmation failure alarms;

- regulating the position of a control valve based on a sensor reading and PID control algorithm;
- setting and maintaining the state of several valves in a material header.

#### **5.2.2.4.1 Basic control in control modules**

Control modules contain basic control. Although this control is normally either regulatory or state oriented, in some cases it is both. It may also include conditional logic. For example, open the valve if the temperature is within limits and the downstream valve is open.

Regulatory control is dedicated to maintaining a process variable or variables at or near some desired value. Complex control strategies such as multivariable control, model-based control, and artificial intelligence techniques may also fit into this category of regulatory control.

State-oriented control refers to setting the state of a piece of equipment as opposed to the state of a process variable or variables. A state-oriented device has a finite number of states. It defines a product independent processing sequence.

Control modules may contain exception handling.

#### **5.2.2.4.2 Procedural control in control modules**

Control modules do not perform procedural control.

#### **5.2.2.4.3 Coordination control in control modules**

Coordination control in a control module may include, for example, algorithms for propagating modes and for arbitrating requests from units for usage.

### **5.2.3 Structuring of equipment entities**

This section discusses the general principles involved in segmenting a process cell into equipment entities that can carry out specified processing activities or equipment-specific actions. Total explanation of process segmentation principles is beyond the scope of this standard.

It is important to note that the physical process cell design can greatly influence the implementation of batch control. Minor differences in the physical system can dramatically affect the organization of equipment entities and procedural elements.

All control related sections of the standard assume that the process cell in question (both physical equipment and related control activities) has been subdivided into well defined equipment entities such as units, equipment modules, and control modules. Effective subdivision of the process cell into well-defined equipment entities is a complex activity, highly dependent on the individual requirements of the specific environment in which the batch process exists. Inconsistent or inappropriate equipment subdivisions can compromise the effectiveness of the modular approach to recipes suggested by this standard.

Subdivision of the process cell requires a clear understanding of the purpose of the process cell's equipment. Such understanding allows the identification of equipment entities that must work together to serve an identifiable processing purpose.

#### **5.2.3.1 Structuring of process cells**

The subdivision of a process cell usually follows the principles listed below :

- The function any equipment entity serves in product processing must be clear and unambiguous.

- The function performed by the equipment entity must be consistent in terms of processing task, and should be usable for that task no matter what product is being manufactured at a given time.
- Subordinate equipment entities should be able to execute their task(s) independently and asynchronously, allowing the highest level equipment entity to orchestrate the activities of its subordinates.
- Interactions between equipment entities should be minimized. While planned interaction is periodically necessary, each equipment entity should perform its functions while influencing the functioning of other equipment entities as little as possible.
- Equipment entities must have clear boundaries.
- A consistent basis is required for the definition of equipment entities. An operator subsequently interacting with similar equipment entities should be able to do so naturally and without confusion.
- Necessary interaction between equipment entities is, insofar as possible, coordinated by equipment entities at the same level or at the next higher level.

#### **5.2.3.2 Structuring of units**

The definition of a unit requires knowledge of the major processing activities, as well as the equipment capabilities. The following guidelines apply:

- One or more major processing activities, such as reaction or crystallization, may take place in a unit.
- Units should be defined such that they operate relatively independently of each other.
- A unit is presumed to operate on only one batch at a time.

#### **5.2.3.3 Structuring of equipment modules**

The definition of an equipment module requires knowledge of specific minor processing activities and equipment capabilities. Equipment modules can carry out a finite number of minor processing activities, such as dosing and weighing, and are typically centered around a set of process equipment. Collections of control modules can be defined as equipment modules or as control modules. If the collection executes one or more equipment phases, then it is an equipment module.

### **5.3 Recipes**

This section discusses the four types of recipes covered in this standard, the five categories of information contained in a recipe and how this information changes for the different recipe types, and the relationship of the control recipe procedure to the equipment procedure. Some guidelines for recipe transportability are also presented.

#### **5.3.1 Recipe types**

This section discusses four types of recipes typically found in an enterprise. A recipe is an entity that contains the minimum set of information that uniquely defines the manufacturing requirements for a specific product. Recipes provide a way to describe products and how those products are produced. Depending on the specific requirements of an enterprise, other recipe

types may exist. However, this standard discusses only the general recipe, site recipe, master recipe, and control recipe (see Figure 8).

Fundamental to the practical application of recipes is the concept that different parts of an enterprise may need information about the manufacture of a product in varying degrees of specificity, because different recipients of the information use it for different purposes. Therefore, more than one type of a recipe is needed in an enterprise.

It should be noted that whether a particular recipe type actually exists, who generates it, and where it is generated will vary from case to case and from enterprise to enterprise. For example, an enterprise may choose not to implement one or more of the recipe types.

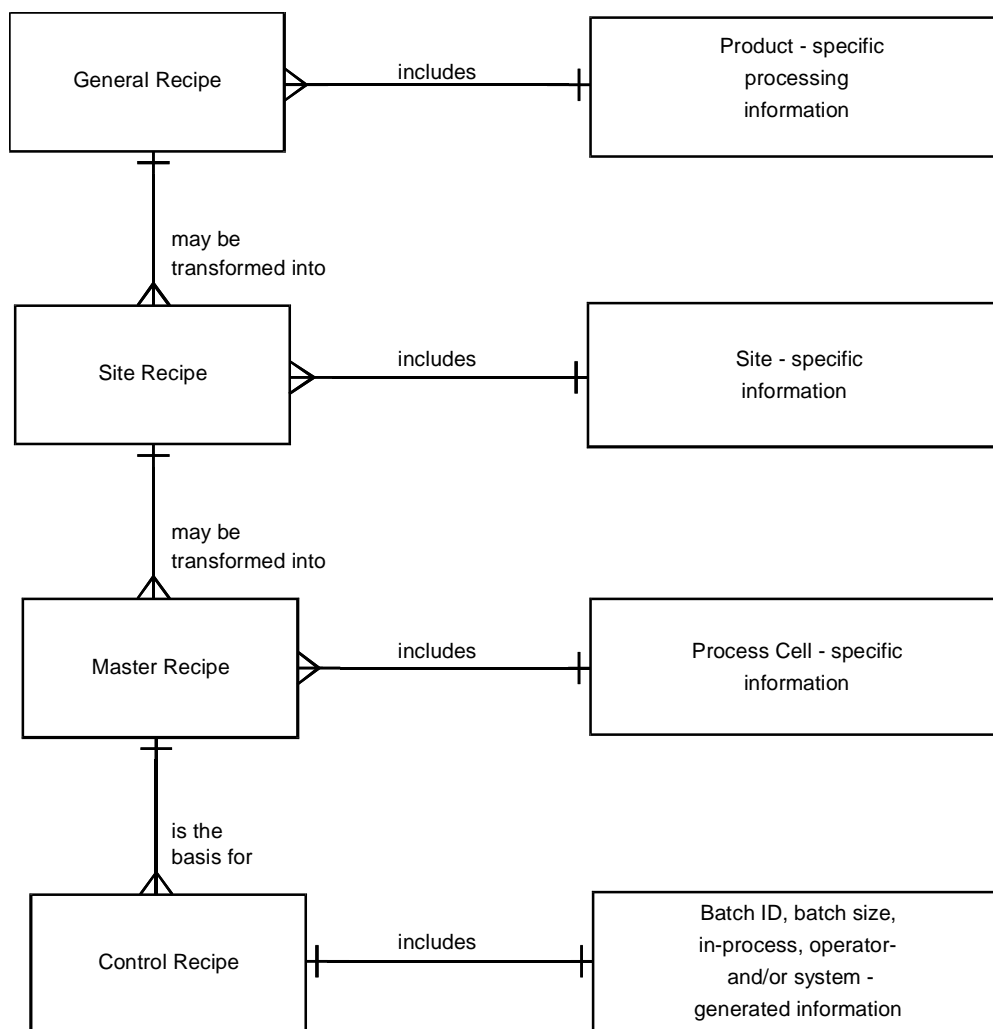

**Figure 8 — Recipe types**

A product may be made in many different arrangements of equipment at many different sites. Recipes that are appropriate for one site or set of equipment may not be appropriate for another site or set of equipment. This can result in multiple recipes for a single product. There should be sufficient structure in the definition of recipes to allow tracing of the genealogy of any given recipe.

The recipe contains neither scheduling nor equipment control. The recipe contains process-related information for a specific product. This permits batch processing equipment to make many different products without having to redefine equipment control for each product.

There is a substantial difference between general/site recipes and master/control recipes. The general and site recipes describe the technique, that is, how to do it in principle. Master and control recipes describe the task, that is, how to do it with actual resources.

#### **5.3.1.1 General recipe**

The general recipe is an enterprise level recipe that serves as the basis for lower-level recipes. The general recipe is created without specific knowledge of the process cell equipment that will be used to manufacture the product. It identifies raw materials, their relative quantities, and required processing, but without specific regard to a particular site or the equipment available at that site. It is created by people with knowledge of both the chemistry and processing requirements peculiar to the product in question, and reflects their interests and concerns.

While the general recipe is not specific to equipment or to a particular site, the technology for manufacturing a product will usually have evolved sufficiently beyond the laboratory so that equipment requirements can be described in enough detail to define the type of equipment needed at a particular site or in a particular set of batch plant equipment. The general recipe provides a means for communicating processing requirements to multiple manufacturing locations.

Quantities may be expressed as fixed or normalized values; equipment requirements are expressed in terms of the attributes needed by the equipment, such as pressure requirements and materials of construction.

The general recipe may be used as a basis for enterprise-wide planning and investment decisions. It may be part of, or referenced by production specifications and, as such, used for production planning and for information to customers and authorities.

#### **5.3.1.2 Site recipe**

The site recipe is specific to a particular site. It is the combination of site-specific information and a general recipe. It is usually derived from a general recipe to meet the conditions found at a particular manufacturing location and provides the level of detail necessary for site-level, long-term production scheduling. However, it may also be created directly without the existence of a general recipe. Such things as the language in which it is written or local raw material differences are accommodated as site-specific variances. It is still not specific to a particular set of process cell equipment. Typically, the site recipe is the output of a local "site focused" process development function.

There may be multiple site recipes derived from a general recipe, each covering a part of the general recipe that may be implemented at a specific site.

#### **5.3.1.3 Master recipe**

The master recipe is that level of recipe that is targeted to a process cell or a subset of the process cell equipment. A master recipe can be derived from a general recipe or a site recipe. It can also be created as a stand-alone entity if the recipe creator has the necessary process and product knowledge.

Some characteristics of master recipes include the following:

- There may be multiple master recipes derived from a site recipe, each covering a part of the site recipe that may be implemented in a process cell.
- The master recipe has to be sufficiently adapted to the properties of the process cell equipment to ensure the correct processing of the batch. This is done by combining the functionality of the specific set of process cell equipment with the information from the master recipe.
- In a master recipe, the formula data may be specified as normalized values, calculated values, or fixed values.
- The master recipe may contain product-specific information required for detailed scheduling, such as process input information or equipment requirements.
- The master recipe level is a required recipe level, because without it no control recipes can be created and, therefore, no batches can be produced.
- Whether the batch manufacturing equipment is operated manually or fully automatically, the master recipe exists either as an identifiable set of written instructions or as an electronic entity.

#### **5.3.1.4 Control recipe**

The control recipe starts as a copy of a specific version of a master recipe and is then modified as necessary with scheduling and operational information to be specific to a single batch. It contains product-specific process information necessary to manufacture a particular batch of product. It provides the level of detail necessary to initiate and monitor equipment procedural entities in a process cell. It may have been modified to account for actual raw material qualities and actual equipment to be utilized. The selection of units and appropriate sizing can be done any time before that information is needed.

Since modifications of a control recipe can be made over a period of time based on scheduling, equipment, and operator information, a control recipe may go through several modifications during the batch processing. Examples include

- defining the equipment that will actually be used for the control recipe at the initiation of the batch or when it becomes known;
- adding or adjusting parameters based on an "as-charged" raw material quality or mid-batch analysis;
- changing the procedure based on some unexpected event.

#### **5.3.2 Recipe contents**

Recipes contain the following categories of information: header, formula, equipment requirements, procedure, and other information. The following subparagraphs provide details regarding these categories. Any significant changes from one recipe type to another are noted.

##### **5.3.2.1 Header**

The administrative information in the recipe is referred to as the header. Typical header information may include the recipe and product identification, the version number, the originator, the issue date, approvals, status, and other administrative information. For example, a site recipe may contain the name and version of the general recipe from which it was created.

### **5.3.2.2 Formula**

The formula is a category of recipe information that includes process inputs, process parameters, and process outputs.

A process input is the identification and quantity of a raw material or other resource required to make the product. In addition to raw materials which are consumed in the batch process in the manufacture of a product, process inputs may also include energy and other resources such as manpower. Process inputs consists of both the name of the resource and the amount required to make a specific quantity of finished product. Quantities may be specified as absolute values or as equations based upon other formula parameters or the batch or equipment size. Process inputs may specify allowable substitutions, expressed in the same basic form.

A process parameter details information such as temperature, pressure, or time that is pertinent to the product but does not fall into the classification of input or output. Process parameters may be used as set points, comparison values, or in conditional logic.

A process output is the identification and quantity of a material and/or energy expected to result from one execution of the recipe. This data may detail environmental impact and may also contain other information such as specification of the intended outputs in terms of quantity, labeling, and yield.

The types of formula data are distinguished to provide information to different parts of an enterprise and need to be available without the clutter of processing details. For example, the list of process inputs may be presented as a condensed list of ingredients for the recipe or as a set of individual ingredients for each appropriate procedural element in a recipe.

### **5.3.2.3 Equipment requirements**

Equipment requirements constrain the choice of the equipment that will eventually be used to implement a specific part of the procedure.

In the general and site recipes, the equipment requirements are typically described in general terms, such as allowable materials and required processing characteristics. It is the guidance from and constraints imposed by equipment requirements that will allow the general or site recipe to eventually be used to create a master recipe which targets appropriate equipment. At the master recipe level, the equipment requirements may be expressed in any manner that specifies allowable equipment in process cells. If trains have been defined, then it is possible for the master recipe (and the resulting control recipe) to be based on the equipment of the train rather than the full range of equipment in the process cell. At the control recipe level, the equipment requirements are the same as, or a subset of, the allowable equipment in the master recipe. The control recipe may be used to include specific allocations of process cell equipment, such as Reactor R-501, when this becomes known.

### **5.3.2.4 Recipe procedure**

The recipe procedure defines the strategy for carrying out a process. The general and site recipe procedures are structured using the levels described in the process model since these levels allow the process to be described in non-equipment specific terms. The master and control recipe procedures are structured using the procedural elements of the procedural control model, since these procedural elements have a relationship to equipment.

The recipe creator is limited to the use of procedural elements that have been, or will be, configured and made available for use in creating a procedure. He or she may use any combination of these procedural elements to define a procedure. Determination of which of these procedural elements may be part of the procedure is an application specific design decision based on many factors including the capabilities of the controls and the degrees of freedom appropriate for the recipe creator in a given application.

### 5.3.2.4.1 General recipe procedure

The procedure information in the general recipe is expressed in three levels of breakdown: Process Stages, Process Operations, and Process Actions (see Figure 9). The functionality of these levels corresponds to the functionality of the analogous levels in the Process Model (see 4.1.3).

The process stage, process operation, and process action are not constrained by unit boundaries in any real plant. They describe processing activities that others may choose to execute in one or in many different units as the general and site recipe is transformed to run in one or more real plants.

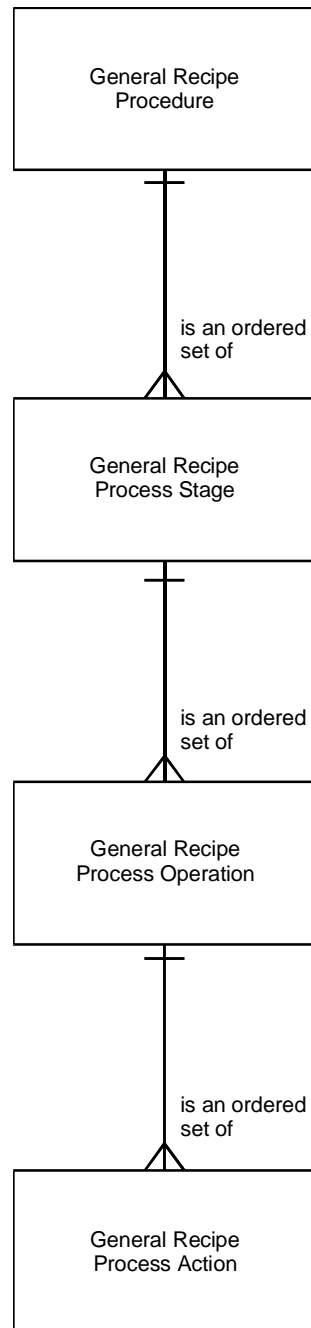

**Figure 9 — General recipe procedure**



#### 5.3.2.4.2 Site recipe procedure

The procedure information in a site recipe consists of process stages, process operations, and process actions that relate directly to those defined by the general recipe. In general, there is a 1:1 correspondence between the process stages in a general recipe and the process stages in a site recipe, between the process operations in a general recipe and the process operations in a site recipe, and between the process actions in a general recipe and the process actions in a site recipe. As with the other site recipe information, the process stages, process operations, and process actions may be modified to make the recipe site-specific.

#### 5.3.2.4.3 Master recipe procedure

The recipe procedure portion of the master recipe may contain recipe unit procedures, recipe operations, and recipe phases (see Figure 10).

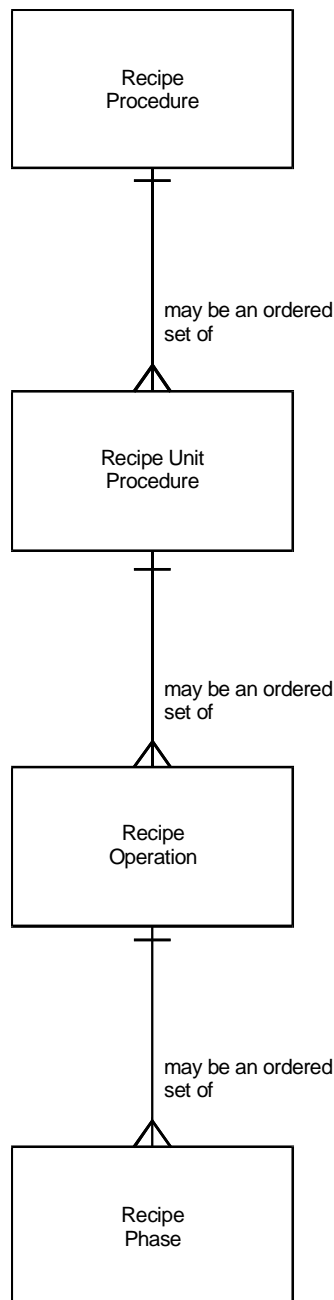

**Figure 10 — Master recipe procedure**

The creation of a procedure in a master recipe from a procedure in a site recipe may be quite complex. The master recipe must contain sufficiently detailed equipment requirements information so that resources may be determined and allocated to create and initiate a control recipe. It is at this recipe level that the set of recipe phases necessary to carry out the intended process actions, process operations, and process stages can be determined.

There may be a 1:1, 1:n, or n:1 relationship between process actions in the general or site recipe and recipe phases in the master recipe, between process operations in the general or site recipe and recipe operations in the master recipe, and between process stages in the general or site recipe and recipe unit procedures in the master recipe (see Figure 11). The actual relationship may depend on the equipment being used.

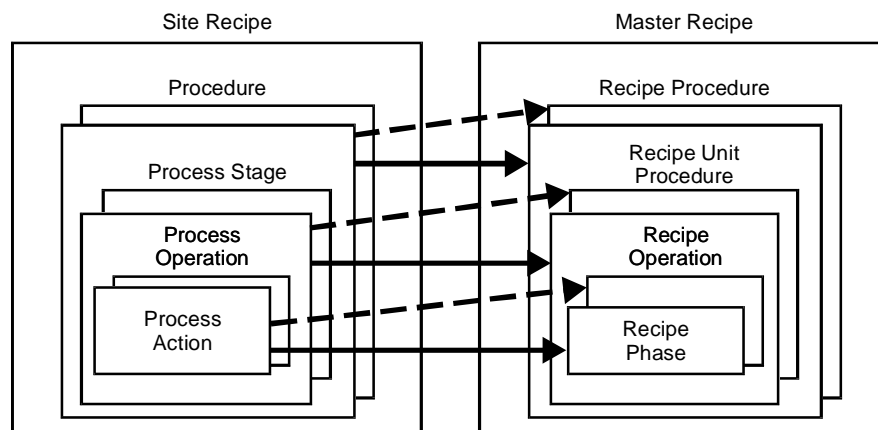

**Figure 11 — Procedural element relationships in the site recipe and master recipe**

Although there is a general similarity between the processing intent of process actions and the processing function defined by recipe phases, there is not necessarily a one-to-one correspondence between the two. One process action may correspond to several recipe phases, and several process actions may correspond to a single recipe phase.

There is a similar relationship between process operations and operations. There are significant differences also. Operations are carried to completion in a single unit in the target equipment while process operations are not constrained to units in any specific facility. A single process operation might require one or more operations to carry out the processing intent described.

There is a similar relationship between process stages and unit procedures as there is between process operations and operations. Unit procedures are also carried to completion in a single unit in the target equipment while process stages are not constrained by equipment boundaries in any specific facility. A single process stage might require one or more unit procedures to carry out the processing intent described.

#### **5.3.2.4.4 Control recipe procedure**

The procedure of a control recipe consists of recipe unit procedures, recipe operations and recipe phases that relate directly to those defined by the master recipe. At the control recipe creation time, there is a 1:1 correspondence between recipe unit procedures in the master recipe and recipe unit procedures in the control recipe, between recipe operations in the master recipe and recipe operations in the control recipe, and between recipe phases in the master recipe and recipe phases in the control recipe. Changes in the control recipe procedure during the execution may cause it to differ from the master recipe procedure. In a control recipe, as in a master recipe, the procedure is divided along unit procedure boundaries to provide the process cell with the processing requirements of the recipe on a unit-by-unit basis.

#### **5.3.2.5 Other information**

Other information is a category of recipe information that may contain batch processing support information not contained in other parts of the recipe. Examples include regulatory compliance information, materials and process safety information, process flow diagrams, and packaging/labeling information.

### **5.3.3 Control recipe procedure/equipment control relationship**

The control recipe itself does not contain enough information to operate the process cell. It must be linked to equipment control that actually causes the equipment to operate and make batches. Equipment control is not considered to be part of the recipe. This section discusses the separation between the control recipe procedure and equipment control, the procedural elements that are used in the control recipe procedure and in equipment control, and the mechanism that is used to link the control recipe procedure with equipment control.

#### **5.3.3.1 Control recipe procedure/equipment control separation**

Figure 12 shows the separation between the control recipe procedure and equipment control. The control recipe procedure must contain at least one procedural element, which is the recipe procedure. Equipment control must also contain at least one procedural element that provides the linkage needed to operate the physical equipment. For the example described in Figure 12, this is assumed to be the equipment phase.

The control recipe procedure might not include recipe unit procedures, recipe operations, and recipe phases. Such a recipe procedure must then be linked (by reference) to an equipment procedure in equipment control if batches are to be executed. Whenever a procedural element, such as a recipe procedure, recipe unit procedure, recipe operation, or recipe phase, is linked to equipment control, it must exist as that recipe procedural element (such as a recipe operation) and as that equipment procedural element (such as an equipment operation). Whenever recipe phases are used in the control recipe procedure, recipe phases are linked to equipment phases.

When recipe unit procedures, recipe operations, and recipe phases are not used as part of the control recipe procedure, it may still be helpful to use lower level equipment procedural elements (some or all) as part of equipment control to provide a modular structure to the equipment control.

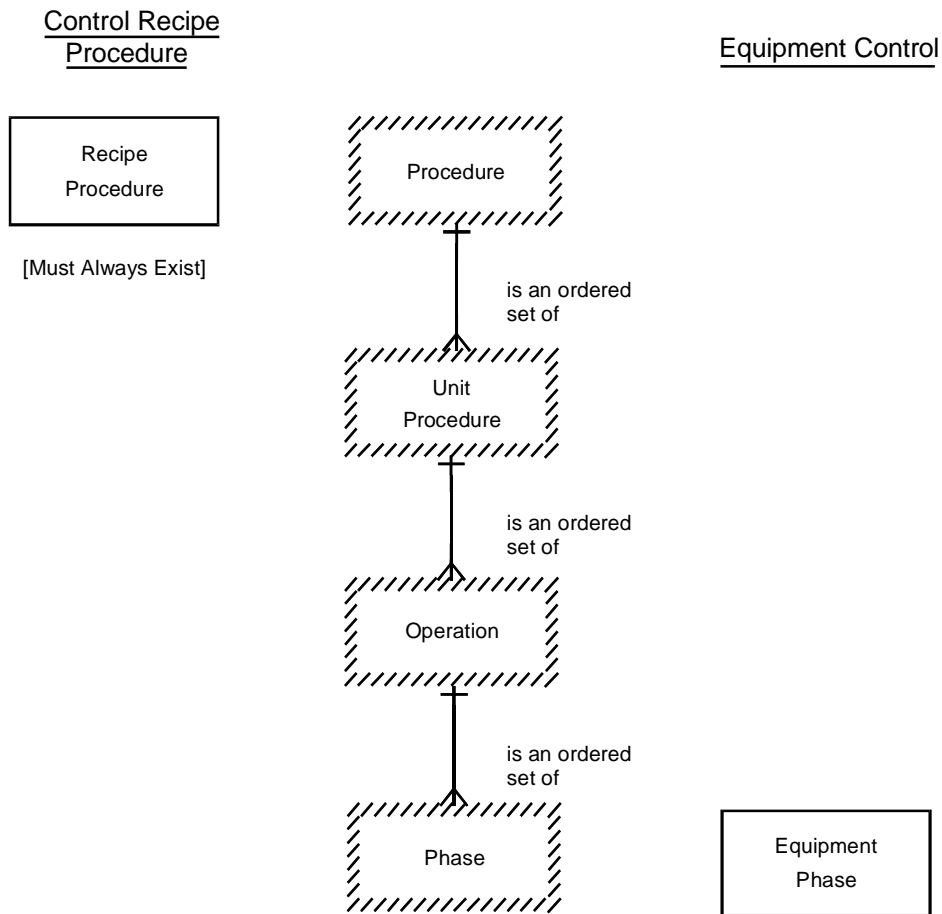

NOTE – The boxes with slashed lines for borders are highlighted to point out that these procedural elements may be part of either the control recipe procedure or equipment control.

**Figure 12 — Control recipe procedure/equipment control separation**

### 5.3.3.2 Control recipe/equipment procedural elements

The following are typically associated with recipe procedural elements:

- A description of the functionality required
- Formula and other parameter information specific to the procedural element
- Equipment requirements specific to the procedural element

In order for a recipe procedural element to be able to reference an equipment procedural element, it must have an identification that enables the element to be correctly linked. In other cases, it must reference or include other recipe procedural elements and a specification of the execution order of those procedural elements.

The equipment procedural element to be linked typically has the following:

- An identification that can be referenced by the recipe procedural element or a higher level equipment procedural element

- A description of the functionality provided
- Variables that can receive the formula and other parameter information from the recipe
- Execution logic

It is possible for the recipe creator to work with a higher level procedural element for defining the procedure and still have the lower level procedural elements as part of the procedure. This could occur when the higher level procedural element has been pre-configured in terms of one or more lower level procedural elements. When the recipe creator invokes the use of a higher level procedural element, the lower level procedural elements are carried along, even though they may be invisible to the recipe creator, and become part of the procedure.

When a procedural element is used more than once in a recipe, there may be a need to uniquely identify each occurrence of the procedural element to the operator and batch history.

### **5.3.3.3 Control recipe procedure/equipment control linking**

There must be some method to link the control recipe procedural elements with the equipment procedural elements. The examples below demonstrate this linkage between the control recipe procedure and equipment control when all procedural elements from the procedural control model are used in the application.

This linking is done by associating the recipe procedural elements with equipment procedural elements. In this way, the call for a certain processing function is separated from equipment control. It also enables the same recipe procedural element to use different equipment procedural elements, depending on what equipment the recipe addresses.

An equipment phase may be initiated by things other than the execution of a control recipe. It may be initiated by the request of another unit or on the request of an operator. The independent execution of a phase may be useful for handling exception conditions, during start-up or maintenance, and/or to prepare a unit for production.

If unit procedures, operations, and phases are part of the control recipe procedure, linking (by reference) of the control recipe procedure to equipment control is done at the phase level (see [Figure 13](#)). This drawing applies to one control recipe.

Control Recipe  
Procedure

Equipment Control

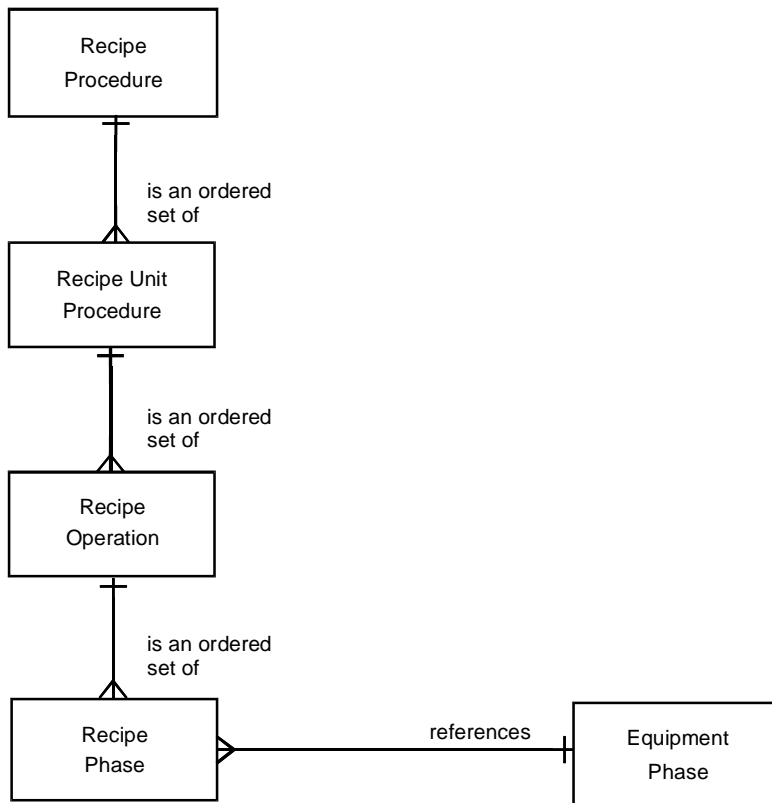

**Figure 13 — Control recipe procedure example with unit procedures, operations, and phases**

If phases do not exist as part of the control recipe but operations do, the linking would be done at the operation level (see Figure 14). This example applies to one control recipe.

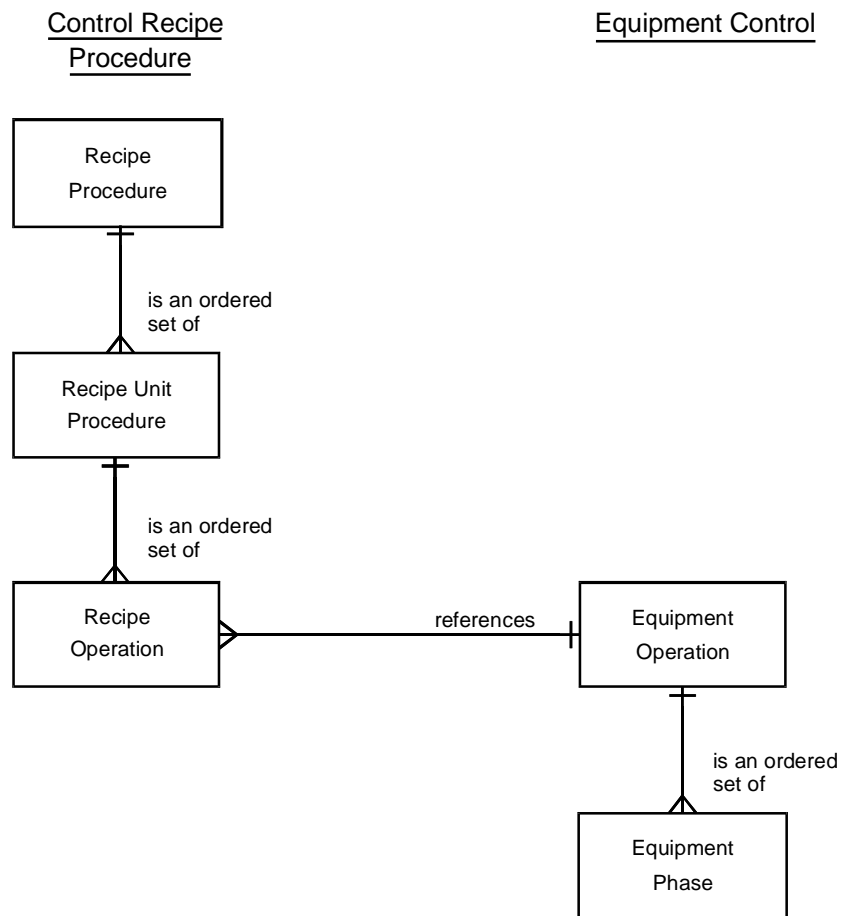

**Figure 14 — Control recipe procedure example with unit procedures and operations**

If neither phases nor operations exist as part of the control recipe but unit procedures do, the linking would be done at the unit procedure level (see Figure 15). This example applies to one control recipe.

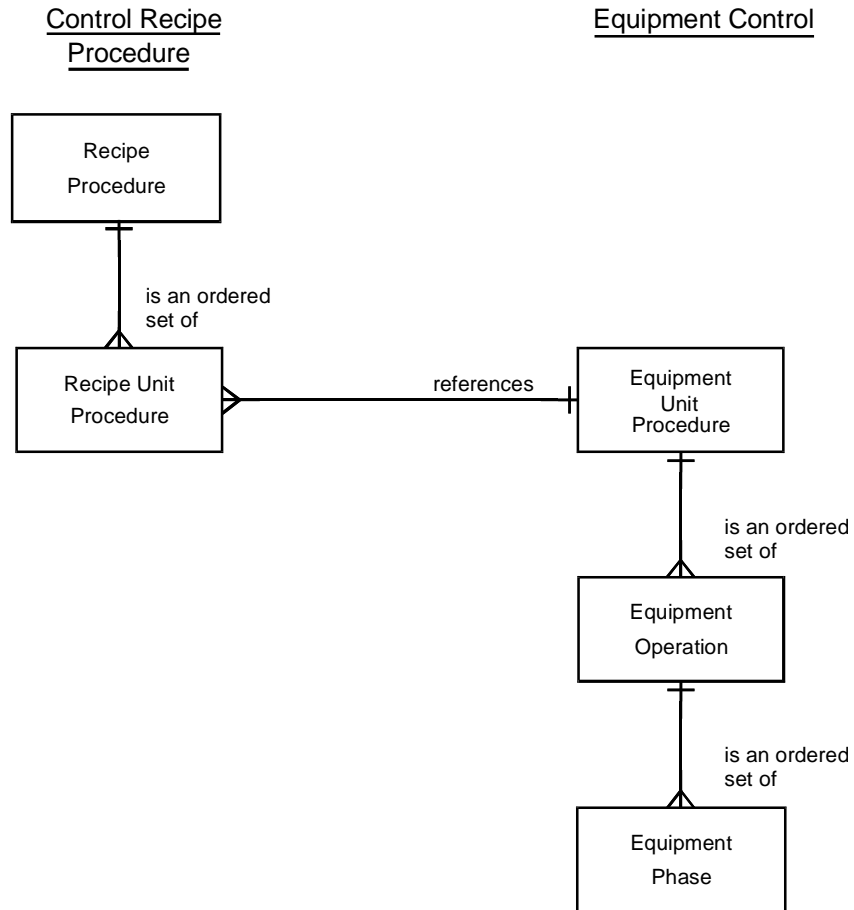

**Figure 15 — Control recipe procedure example with unit procedures**



If only the procedure exists as part of the control recipe, the linking would be done at the procedure level (see Figure 16). This example applies to one control recipe.

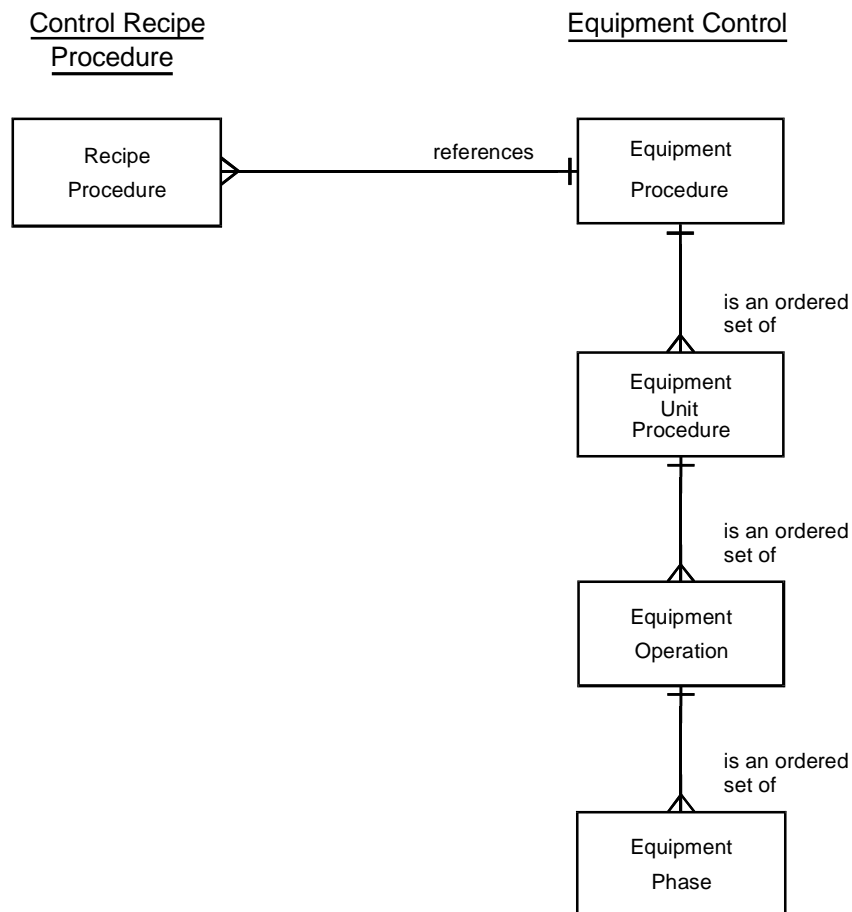

**Figure 16 — Control recipe procedure example with only a procedure**

#### 5.3.3.4 Control recipe procedure/equipment control collapsibility

The preceding examples have assumed that all levels of the procedure model are being used. As with other models of this standard, the procedural control model is collapsible. Levels in the procedural control model may be left out in a specific application. Some examples are discussed below.

If a procedure addresses a single unit, the procedure itself may take the place of the unit procedure, and the recipe procedure has collapsed (see Figure 17a).

Recipe phases alone might be used to define a recipe procedure that addresses a single unit. Then the recipe procedure consists of the phases needed to accomplish the function of the procedure and the strategy needed to organize and properly sequence the phases. The procedure model is collapsed to eliminate the use of unit procedures and operations as overtly stated subdivisions (see Figure 17b).

The same collapsing may happen with an equipment procedure, as shown in Figure 17c, where no unit procedures, operations, or phases are used in the recipe procedure, such as when the recipe procedure has been collapsed to just the procedure name, and no unit procedures or

operations are used in the equipment procedure. So now the equipment procedure is made up of an ordered set of equipment phases.

The phase level may be omitted if a specific application is better described with operations that are not further subdivided. Then the operation interacts directly with basic control (see Figure 17d).

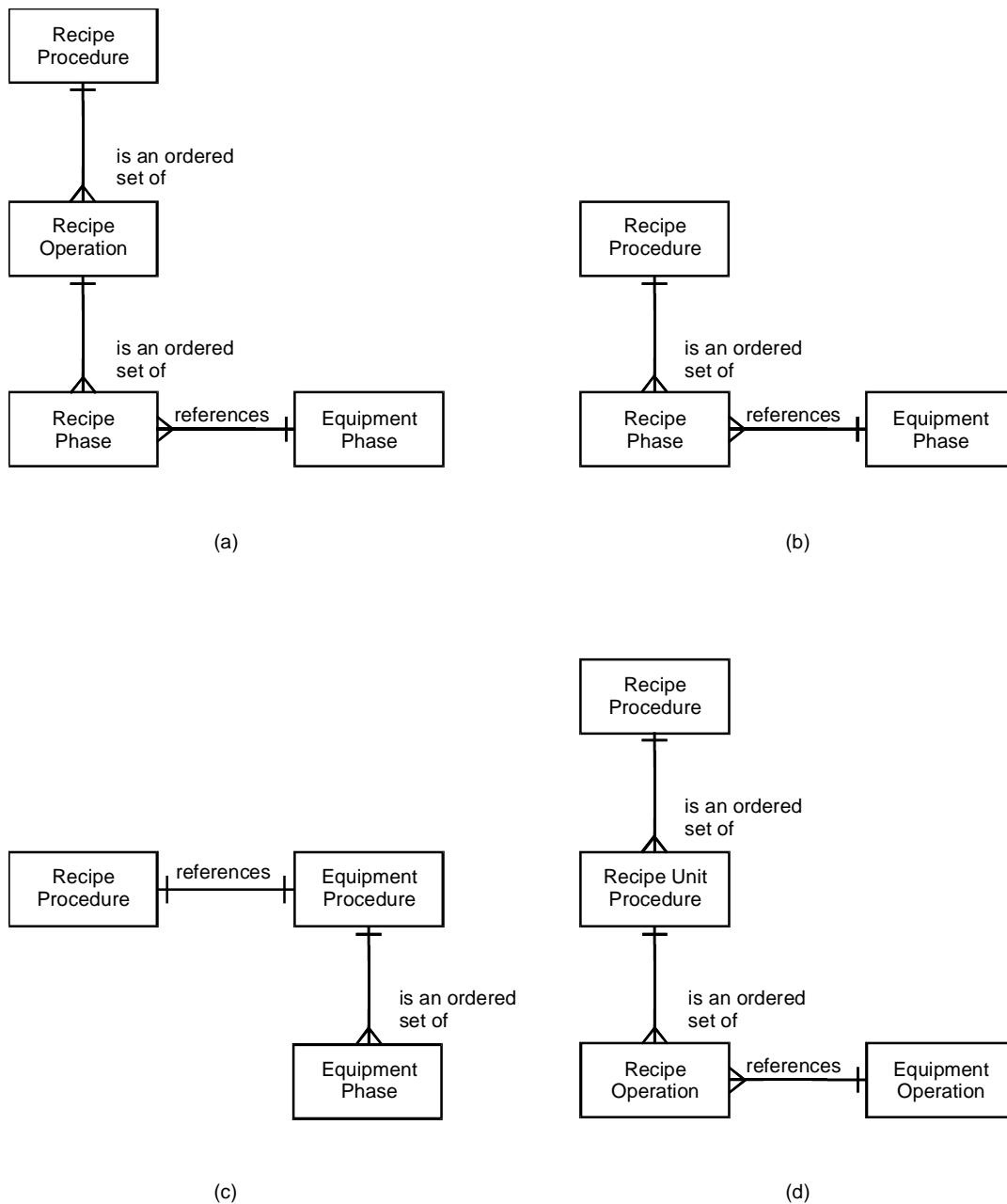

**Figure 17 — Control recipe procedure/equipment control collapsibility examples**

The following considerations must be taken into account when collapsing:

- When a procedural element level is taken out, the next higher level must take over its functions and contain the ordering logic controlling the next lower level and any other information that would have been stated in the collapsed level, including equipment requirements and other information.
- The lowest level of equipment procedural control must have the functionality to activate equipment through basic control.

#### **5.3.4 Recipe transportability**

Recipe transportability ensures that recipe information movement is possible between batch control implementations at the same recipe level. The recipe information must be understood by each implementation.

The general recipe is transportable from where it was created to any site. The site recipe is transportable, but not to the same extent as the general recipe. It is intended to be used within a specific site and is transportable within that site.

The master recipe is transportable to another process cell, recognizing that the master recipe has been customized for a particular set of process cell equipment. When the master recipe is transported to another process cell, some process engineering analysis may be necessary to

- determine that the new set of process cell equipment is configured similarly so that the master recipe can be used unchanged or;
- make the necessary changes so that the modified master recipe will run on the target set of process cell equipment.

The control recipe is not transportable.

### **5.4 Production plans and schedules**

Production plans and schedules state the production requirements for the enterprise, sites, areas, and process cells. Since these levels of the physical model operate on different time horizons, a number of different types of plans and schedules are typically needed within an enterprise. A detailed discussion of the various types of plans and schedules is outside the scope of this standard. Only the scheduling needs at the process cell level, the batch schedule, will be discussed.

The batch schedule typically contains more detailed information than production plans and schedules aimed at higher levels in the enterprise. It contains information such as the products that are to be produced, how much of each product is to be produced, and when they are required for a specific process cell. It identifies which batches are to be made, their order, and the equipment to be used. This schedule also deals with issues such as personnel requirements, raw material options, and packaging requirements.

Time horizons for the batch schedule are dependent on the speed of the processes and might be measured in minutes, hours, shifts, or days. The batch schedule is based on the specific resources and requirements of the process cell. The possible paths and equipment options are determined at this point. For the batch schedule to be totally meaningful, this schedule would need to be redone any time there is significant variance from the time projections, resource assumptions, or other anticipated factors on which the schedule was based. For example, the schedule may have to be updated if an activity is not completed close to the scheduled time. Whether that activity is delayed or whether it is completed ahead of time, the primary concern is

whether that activity can affect other schedules in this process cell or other associated process cells.

The following is the typical information found in a batch schedule:

- Product name
- Master recipe name
- Quantity (with engineering units) of product
- Equipment and materials permitted to be used, such as path and raw material
- Projected mode of operation
- Order of initiation and priority
- Lot ID (if preassigned)
- Batch ID (if preassigned)
- Projected start time and end time
- Disposition of the finished batch
- Specific customer requirements

A key to efficient batch manufacturing is a comprehensive method that links the various plans and schedules with batch data collection. Batch data collection is the source of timely information that provides feedback so that these plans and schedules can be fine tuned. During the actual manufacturing of a batch, information is needed in real time so that schedules can be updated within a short time horizon. This update information also allows the user to be kept apprised of the status of lots and/or batches in the schedule.

## **5.5 Production information**

This section discusses information that is generated in the course of production. Information needs to be collected and made available to various levels of the enterprise. The type of information needed varies between different parts of the enterprise. At the enterprise level, for example, summary information may be all that is needed. Examples include the amount of production of a particular product that was achieved at a specific site or at all sites, or how much product is available in inventory.

Process development may need detailed processing information on the individual batches in order to perform statistics and comparisons. At the process cell level where the batches are actually executed, there is a need for more detailed information in order to monitor the day-to-day production, to perform adjustments to the schedule, or to adjust processing from batch to batch.

Production information may be batch specific or it may be common to several or all of the batches produced.

### **5.5.1 Batch-specific information**

The batch-specific information may include the following:

- A copy of the control recipe that was used to make the batch. This may not be identical to the original recipe because of operator changes, equipment problems, etc. It may be desirable to record both the original recipe and the actual recipe.

- Recipe data. This is actual process data that corresponds exactly to the recipe formula, such as the amount and type of material charged. This can then be compared to the original recipe.
- Recipe-specified data. This is data whose collection is specified by the recipe. An example is process control information to be trended.
- Summary batch data. This is data such as utilities consumption, equipment run times, and temperatures for the entire batch.
- Operator comments
- Continuous data. This is process data that is collected independent of specific events within the batch with the purpose of giving an accurate history of that measurement.
- Event data. This is data from predictable and unpredictable events, such as recording start and stop times of procedural elements, or unpredictable process or equipment events.
- Operator data. This includes any operator intervention that may affect the processing of the batch (includes operator's ID).
- Analysis data. This is data that is related to off-line measurements or analyses such as measured variables, operator ID, lab technician ID, time of entry of results, and time of sample.

### **5.5.2 Common (non-batch specific) batch information**

Examples of common (non-batch specific) batch information include:

- Quality control information. This is information related to monitoring raw material qualities and processing quality.
- Utility systems information. This is process information for equipment such as process heating and cooling that do not produce batches themselves but support equipment that does produce batches.
- Equipment history. This is historical information, such as equipment utilization, calibration, and maintenance.
- Operational documentation. This includes documentation such as production volumes, material consumption summaries, and inventory statistics.
- Materials information. This is typically information such as quality information and packaging and labeling information of input and output materials.

### **5.5.3 Batch history**

All recorded information pertaining to a batch is referred to as the batch history. The batch history will typically include the batch-specific information. Common (non-batch specific) batch information may be included in the batch history. Since information of this nature typically applies to all or several batches being processed in a process cell, it may be included in the individual batch histories by reference.

In many regulated industries, the record of the batch history is as important as the product itself. Without reliable and accurate batch record keeping, product quality and traceability cannot be ensured. Complete batch record keeping also provides information that is invaluable in process analysis and continuous improvement efforts.

Batch history must be stored in a way that makes it possible to associate the data with that batch (or batches) to which it relates and the processing that has taken place. This means that, in

addition to the specific batch identity, the data must be associated with the actual execution of the appropriate procedural elements, where relevant. The structure of the executed procedure may differ from what is specified in the original recipe because of operator intervention, exception handling, or even planned diversity in the procedure, such as changes caused by varying resource limitations.

#### 5.5.4 Batch reports

The extraction of data related to one or more batches is called a batch report. The extraction and ordering of the data in a report may vary based on the intended recipient of the batch report. Some of the typical recipients of batch reports and the types of information typically included in their reports are

- production management: These batch reports typically provide key economic information on the processing result and resource utilization from multiple batches.
- product development: These batch reports typically include detailed process information for an individual batch or compare similar data between a group of batches.
- plant operations: These batch reports typically include the data collected to the current point of processing.
- quality management: These batch reports typically contain information for documenting batch quality, which may be useful in quality statistics.
- authorities: These batch reports are typically provided as documentation of production complying with regulations.
- customers: These batch reports usually are documentation of product quality and process uniformity.

### 5.6 Allocation and arbitration

This section discusses mechanisms for allocating resources to a batch or unit and for arbitrating the use of common resources when more than one requester needs to use a common resource at the same time.

Resources such as equipment are assigned to a batch or a unit as they are needed to complete or to continue required processing. *Allocation* is a form of coordination control that makes these assignments. When more than one candidate for allocation exists, a selection algorithm such as "select lowest duty time" might be used as a basis for choosing the resource. When more than one request for a single resource is made, *arbitration* is needed to determine which requester will be granted the resource. An algorithm such as "first come/first served" might be used as a basis for arbitration.

In the following sections, allocation and arbitration are discussed in terms of equipment. The concepts apply equally well to other resources, such as operators.

#### 5.6.1 Allocation

The very nature of batch processing requires that many asynchronous activities take place in relative isolation from each other with periodic points of synchronization. Many factors, both expected and unexpected, can affect the time required by one or more of the asynchronous activities from one point of synchronization to the next. For those reasons, and because of the inherent variation in any manufacturing process, the exact equipment which will be available at the time it is needed is very difficult to predict over a significant period of time. Even though a

schedule may have been planned to totally optimize the processing sequence from the standpoint of equipment utilization, it often is desirable to allow alternate equipment to be used if the units planned for a batch are not available when planned. In this case the allocation of units to the batch -- the routing or *path* of the batch -- is a decision which must be made every time there is more than one path the batch can take through the available equipment.

If more than one unit can acquire or request the services of a single resource, the resource is designated as a common resource. Common resources are often present with complex batch processes. Common resources are often implemented as either equipment modules or control modules. A common resource may be either exclusive-use or shared-use.

If the resource is designated as exclusive-use, only one unit may use the resource at a time. A shared weigh tank in a batch plant might be an example of an exclusive-use resource. It can be used by only one reactor at a time. The schedule or some other basis for allocation must take this exclusive-use resource into consideration. If a reactor is waiting for the use of the weigh tank while another is using it, the waiting reactor is idle and is not making product, which has a negative effect on equipment utilization.

If the common resource is designated as shared, several units may use the resource at the same time. Some shared-use resources in a batch plant might be a process heater serving multiple units at the same time or a raw material distribution system which is capable of delivering material to more than one unit at a time. If the capabilities of a shared-use resource are limited, then it is possible that the requests for service might exceed the capacity of the resource. In that case some of the same concerns about allocation which apply to exclusive-use resources also apply to shared-use resources. Care must also be taken so that one unit does not improperly shut off or deactivate a resource while other units are using it.

### **5.6.2 Arbitration**

If there are multiple requesters for a resource, arbitration is required so that proper allocations can be made. Arbitration resolves contention for a resource according to some predetermined algorithm and provides definitive routing or allocation direction. The algorithm may take various forms such as a predetermined schedule with reservations, a batch priority scheme, or it might rely upon operator judgment. Arbitration may bring with it two distinct issues which affect complexity, resource reservation and preemption.

Reservation allows a claim to be placed on a resource prior to actual allocation. Reservation allows arbitration to be based on future needs rather than allowing the first request for allocation of an idle resource to take precedence regardless of priority. Preemption occurs when a higher priority batch is allowed to cancel or interrupt the use of a resource assigned to a lower priority batch. When allowed, it is most often associated with allocation of exclusive-use common resource but can apply to allocation of any resource.

## **5.7 Modes and states**

This section discusses the modes and states of equipment entities and of procedural elements. In the preceding sections, models describing equipment entities and procedural elements have been defined. In these models, transitions for procedural elements and for equipment entities occur within each hierarchical level. The status of equipment entities and of procedural elements may be described by their modes and states. Modes specify the manner in which these transitions take place; states specify their current status. Other resources, such as materials, may also have states.

### 5.7.1 Modes

Equipment entities and procedural elements may have modes. Example modes are described in this standard in relation to batch control. The mode of an equipment entity may be based on procedural elements or equipment entities utilizing basic control functions, depending on the main control characteristic of the entity.

This standard uses as examples three modes (automatic, semi-automatic and manual) for procedural elements, and two modes (automatic and manual) for equipment entities. Control modules contain basic control functions and will have automatic and manual modes, whereas a unit running procedural control would also have a semi-automatic mode.

This standard does not preclude additional modes or require the use of the modes defined here. The functionality of the modes presented is felt to be generally useful in most batch applications. By naming the modes and including them in the standard, a defined set of terms is documented that can be used when communicating on batch control issues.

A mode determines how equipment entities and procedural elements respond to commands and how they operate. In the case of procedural elements, the mode determines the way the procedure will progress and who can affect that progression. In the case of a control module, such as an automatic block valve, that contains basic control functions, the mode determines the mechanism used to drive the valve position and who/what, such as another device or an operator, may manipulate it to change its state.

For procedural elements, the mode determines the way the transitions are treated. In the automatic mode, the transitions take place without interruption when the transition conditions are fulfilled. In the semi-automatic mode, the procedure requires manual approval to proceed after the transition conditions are fulfilled. Skipping or re-executing one or more procedural elements, without changing their order, is usually allowed. In the manual mode, the procedural elements and their order of execution are specified manually.

For equipment entities containing basic control functions, the mode determines how their states may be manipulated. In automatic mode equipment entities are manipulated by their control algorithms and in manual mode the equipment entities are manipulated by an operator.

[Table 1](#) lists possible behaviors and commands associated with the example modes.

Equipment entities or procedural elements may change mode. This change can occur if the conditional logic requirements for the change are met by internal logic or by an external command such as one generated by another procedural element or by an operator. A mode change takes place only when the conditions for the change request are met.

A change of mode in one equipment entity type or procedural element type may cause corresponding changes in other types. For example, putting a unit procedure to the *Semi-automatic* mode may cause all lower-level procedural elements in that unit to go to the *Semi-automatic* mode, or, a safety interlock trip may cause several control modules to go to the *Manual* mode with their outputs at minimum value. The propagation can be in either direction, from a higher level entity to a lower level entity, or conversely. This standard does not specify propagation rules.



**Table 1 — Possible implementations of example modes**

Mode	Behavior	Command
<b>Automatic</b> (Procedural)	The transitions within a procedure are carried out without interruption as appropriate conditions are met.	Operators may pause the progression, but may not force transitions.
<b>Automatic</b> (Basic Control)	Equipment entities are manipulated by their control algorithm.	The equipment cannot be manipulated directly by the operator.
<b>Semi-automatic</b> (Procedural Only)	Transitions within a procedure are carried out on manual commands as appropriate conditions are fulfilled.	Operators may pause the progression or re-direct the execution to an appropriate point. Transitions may not be forced.
<b>Manual</b> (Procedural)	The procedural elements within a procedure are executed in the order specified by an operator.	Operators may pause the progression or force transitions.
<b>Manual</b> (Basic Control)	Equipment entities are not manipulated by their control algorithm.	Equipment entities may be manipulated directly by the operator.

### 5.7.2 States

Equipment entities and procedural elements may have states. Example states are described in this standard in relation to batch control. The state completely specifies the current condition of equipment entities or procedural elements. In the case of a valve, the state may be "percent open," and in the case of a procedural element, it may be "running" or "holding."

This standard uses *as an example* a self-consistent set of procedural states and commands. The number of possible states and commands and their names vary for equipment entities and for procedural elements.

Examples of states for procedural elements include running, holding, paused, stopped, aborted, and complete. Examples of states for equipment entities include on, off, closed, open, failed, travelling, tripped, 35% open, and available. Examples of commands applicable to procedural elements are start, hold, pause, stop, and abort.

This standard does not require these states or preclude additional states. The functionality of the states and commands presented is felt to be generally useful in most batch applications. By naming the states and commands and including them in the standard, a defined set of terms is documented that can be used when communicating on batch control issues.

Equipment entities or procedural elements may change state. This change can occur if the conditional logic requirements for the change are met by internal logic or by an external command such as one generated by another procedural element or by an operator.

A change of state in one equipment entity type or procedural element type may cause corresponding changes in other types. For example, putting a unit procedure to the *Held* state may cause all procedural elements in that unit to go to the *Held* state, or, a safety interlock trip may cause all procedural elements in that unit to go to the *Aborting* state. The propagation can be in either direction, from a higher level entity to a lower level entity, or conversely. This standard does not specify propagation rules.

A set of procedural states and commands is provided below as a representative example to illustrate one way to define these procedural states and commands. The list of states and commands is summarized in the state transition matrix (see Table 2). An example state transition diagram is derived from the matrix for the first three lines in the matrix (Idle, Running, Complete) (see Figure 18).

**Table 2 — State transition matrix for example states for procedural elements**

Command		Start	Stop	Hold	Restart	Abort	Reset	Pause	Resume
Initial State	No Command End State	State Transition Matrix							
Idle		Running							
Running	Complete		Stopping	Holding		Aborting		Pausing	
Complete							Idle		
Pausing	Paused		Stopping	Holding		Aborting			
Paused			Stopping	Holding		Aborting			Running
Holding	Held		Stopping			Aborting			
Held			Stopping		Restarting	Aborting			
Restarting	Running		Stopping	Holding		Aborting			
Stopping	Stopped					Aborting			
Stopped						Aborting	Idle		
Aborting	Aborted								
Aborted							Idle		

NOTE – The states ending with "ING" are transient states. If their logic completes normally, then a state transition to the state listed under NO COMMAND END STATE occurs. For example, if the RUNNING state completes normally, then the state automatically transitions to COMPLETE. Execution of the transient states (ending in -ING) is governed by the mode.

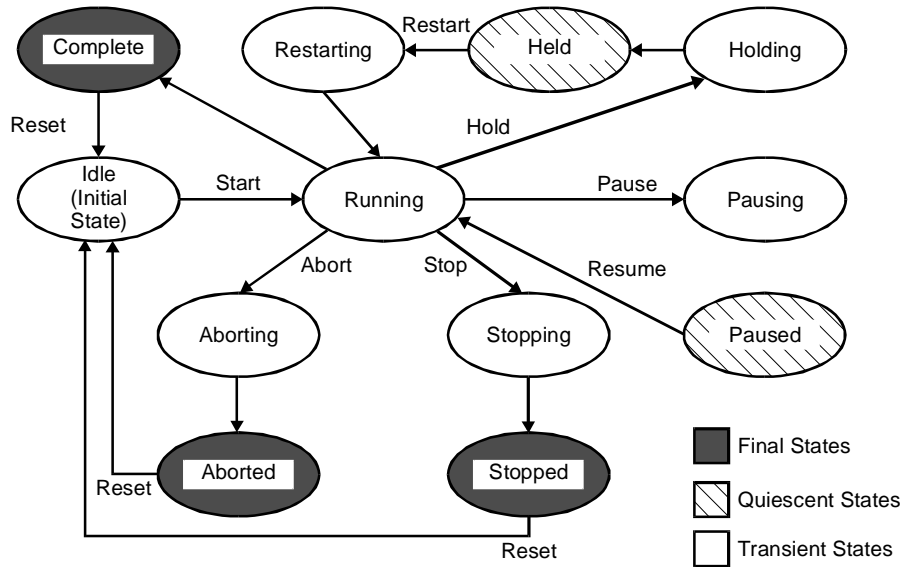

NOTE – This state transition diagram is derived from the first three initial states of the state transition matrix in [Table 2](#) (Idle, Running, Complete)

**Figure 18 — State transition diagram for example states for procedural elements**

### 5.7.2.1 Procedural states

For this example, the list of valid procedural states are the following:

- **IDLE:** The procedural element is waiting for a START command that will cause a transition to the RUNNING state.
- **RUNNING :** Normal operation
- **COMPLETE:** Normal operation has run to completion. The procedural element is now waiting for a RESET command that will cause a transition to IDLE.
- **PAUSING:** The procedural element or equipment entity has received a PAUSE command. This will cause the procedural element to stop at the next defined safe or stable stop location in its normal RUNNING logic. Once stopped, the state automatically transitions to PAUSED.
- **PAUSED:** Once the procedural element has paused at the defined stop location, the state changes to PAUSED. This state is usually used for short-term stops. A RESUME command causes transition to the RUNNING state, resuming normal operation immediately following the defined stop location.
- **HOLDING:** The procedural element has received a HOLD command and is executing its HOLDING logic to put the procedural element or equipment entity into a known state. If no sequencing is required, then the procedural element or equipment entity transitions immediately to the HELD state.

- **HELD:** The procedural element has completed its HOLDING logic and has been brought to a known or planned state. This state is usually used for a long-term stop. The procedural element or equipment entity is waiting for a further command to proceed.
- **RESTARTING:** The procedural element has received a RESTART command while in the HELD state. It is executing its restart logic in order to return to the RUNNING state. If no sequencing is required, then the procedural element or equipment entity transitions immediately to the RUNNING state.
- **STOPPING:** The procedural element has received a STOP command and is executing its STOPPING logic, which facilitates a controlled normal stop. If no sequencing is required, then the procedural element or equipment entity transitions immediately to the STOPPED state.
- **STOPPED:** The procedural element has completed its STOPPING logic. The procedural element or equipment entity is waiting for a RESET command to transition to IDLE.
- **ABORTING:** The procedural element has received an ABORT command and is executing its ABORT logic, which is the logic that facilitates a quicker, but not necessarily controlled, abnormal stop. If no sequencing is required, then the procedural element transitions immediately to the ABORTED state.
- **ABORTED:** The procedural element has completed its ABORTING logic. The procedural element is waiting for a RESET command to transition to IDLE.

#### 5.7.2.2 Commands

For this example, the list of valid commands are the following:

- **START:** This command orders the procedural element to begin executing the normal RUNNING logic. This command is only valid when the procedural element is in the IDLE state.
- **STOP:** This command orders the procedural element to execute the STOPPING logic. This command is valid when the procedural element is in the RUNNING, PAUSING, PAUSED, HOLDING, HELD, OR RESTARTING state.
- **HOLD:** This command orders the procedural element to execute the HOLDING logic. This command is valid when the procedural element is in the RUNNING, PAUSING, PAUSED or RESTARTING state.
- **RESTART:** This command orders the procedural element to execute the RESTARTING logic to safely return to the RUNNING state. This command is only valid when the procedural element is in the HELD state.
- **ABORT:** This command orders the procedural element to execute the ABORTING logic. The command is valid in every state except for IDLE, COMPLETED, ABORTING and ABORTED.
- **RESET:** This command causes a transition to the IDLE state. It is valid from the COMPLETE, ABORTED, and STOPPED states.
- **PAUSE:** This command orders the procedural element to pause at the next programmed pause transition within its sequencing logic and await a RESUME command before proceeding. This command is only valid in the RUNNING state.

- **RESUME:** This command orders a procedural element that has PAUSED at a programmed transition as the result of either a PAUSE command or a SINGLE STEP mode to resume execution. This command is only valid when the procedural element is in the PAUSED state.

## 5.8 Exception handling

An event which occurs outside the normal or desired behavior of batch control is commonly called an exception. Handling of these exceptions can occur at all of the levels in the control activity model and may be part of procedural, basic, and coordination control.

Exception handling is an essential function of batch manufacturing. Exception handling is an integral part of all control and typically constitutes a very large portion of the control definition.

Examples of events that may indicate the need for exception handling are

- unavailability of raw materials, utilities, or plant equipment when needed;
- product or process problems;
- control equipment malfunction;
- hazardous conditions such as fire or chemical spills.

From the standpoint of control, exception handling is no different from desired control strategies in that an event is detected, evaluated, and a response generated.

Exception response functions may affect the modes and states of equipment entities and of procedural elements. For example, high pressure in a reactor could lead to the exception response function transferring the process to a STOPPED state, or an operator could detect some unusual condition and initiate similar action.

---

## 6 Batch control activities and functions

---

This section discusses control functions that are associated with the batch processing, manufacturing, and control tasks described in the previous two sections. The control functions defined in this section elaborate on the control tasks defined in Section 5.1 for the equipment entities discussed in Section 5.2, which are the bottom four levels of the Physical Model described in Section 4.2. Control functions that meet the control needs of the higher levels of the Physical Model are also described. For convenience purposes, these control functions have been grouped into, and are discussed in the context of, control activities. The control activities that are discussed in this section are Recipe Management, Production Planning and Scheduling, Production Information Management, Process Management, Unit Supervision, Process Control, and Personnel and Environmental Protection. The intent of this section is to clearly identify the individual functionality associated with batch control. This will make it easier to define the requirements for batch control for a given application.

## 6.1 Control activities

Many control functions must be implemented to successfully manage batch production. These control functions define how equipment in the batch manufacturing plant will be controlled. They are needed to support the equipment entities described previously. They are combined into seven control activities, as represented in the Control Activity Model of Figure 19.

### 6.1.1 Control activity model

The Control Activity Model in Figure 19 provides an overall perspective of batch control and shows the main relationships between the various control activities. It is not intended to show all relationships. These relationships are achieved via information flow between the control activities. The purpose of this drawing is simply to show where there is a relationship and not to define that relationship. The definition of these relationships will take place later in this section as the control functions grouped within each control activity are discussed. A few of the relationships shown in Figure 19 are not discussed further in this standard.

The control activities shown relate to real needs in a batch manufacturing environment. The need to have control functions that can manage general, site, and master recipes implies a need for the Recipe Management control activity. Production of batches must occur within a time domain that is planned and subsequently carried out. Production Planning and Scheduling is the control activity where these control functions are discussed. Various types of production information must be available, and the collection and storage of batch history is a necessity. The Production Information Management control activity in the model covers these control functions.

Control recipes must be generated, batches must be initiated and supervised, unit activities require coordination, and logs and reports must be generated. These control functions fall under the Process Management control activity in the model. There are many control functions needed at the Unit Supervision control activity level. For example, there is a need to allocate resources, to supervise the execution of procedural elements, and to coordinate activities taking place at the Process Control level. In Process Control, control functions are discussed that deal directly with equipment actions such as the need to implement control functions using regulating devices and/or state-oriented devices.

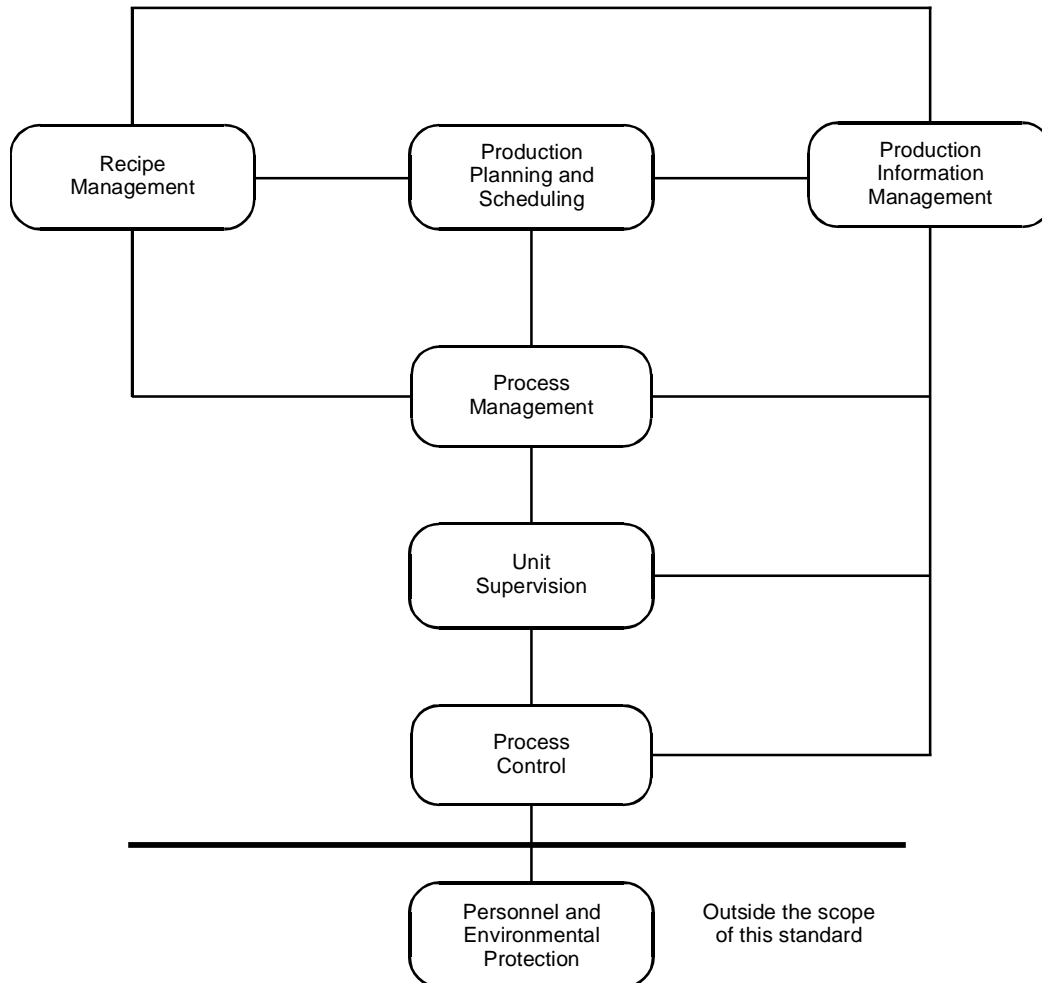

**Figure 19 — Control activity model**

Finally, the safety of personnel and the surrounding communities must be a prime concern, along with protection of the environment. The Personnel and Environmental Protection control activity covers these control functions.

### 6.1.2 Information handling

One dimension of the control activity model is its description of information flow throughout the levels. As such, there are a number of information handling functions that can be applied to all categories of data addressed by the control activity model. These are applicable regardless of the combination of manual and computerized systems that are established at a site. Additional information handling aspects that are specific to a particular control activity are described within their respective sections.

### **6.1.2.1 Reference information**

The batch manufacturing enterprise may incorporate activities that fall outside the scope of this standard. Examples include

- material inventory management;
- process and product development;
- customer service support;
- regulatory reporting and process validation; and
- inter-departmental coordination, such as production versus support services.

To provide an interface to these information sources, the control activities discussed in this section need to store information in a way that provides a usable, accessible data source to these external activities. Similarly, each control activity should have the ability to access relevant reference information as needed to fulfill its function.

Examples of reference information include

- sales or marketing data, including customer orders or other statements of product demand;
- raw material vendor data;
- final products specifications;
- costing data;
- research and development data;
- standard consumptions of raw materials and standard yields for the products manufactured;
- rate information for the various process cells;
- equipment capability specifications;
- operational procedures for equipment maintenance and process safety;
- human resource information;
- quality control information such as the procedure used to perform a particular laboratory analysis; and
- regulatory requirements.

Reference information may be enterprise-wide, site-wide, area-wide, or process cell-wide.

### **6.1.2.2 Security**

Within the control environment, information is used to impact the control functions, to communicate between levels and entities, and to provide communication to control functions outside of the control activity model. Access to this information is restricted to ensure that only authorized and/or qualified resources can affect the information.

### **6.1.2.3 Availability**

Control activity information should be stored and retrieved in a way that provides the necessary safeguards to ensure access to critical data. The time necessary to recover access to the data in case of loss at one location should be considered carefully. These considerations will vary based



on the different levels of the control activity model, the types of information, and the level of detail required.

#### **6.1.2.4 Archival**

Removal of information from the control activity and into a long-term archive is often desirable to improve storage efficiency and recoverability. Once archived, it should be possible to retrieve the archived data in a usable form. For example, once a master recipe is no longer in active use, it would be useful to be able to extract all information (both structural and historical) related to that master recipe from the main repository.

#### **6.1.2.5 Change management**

Information that defines control — including configuration of equipment control and recipes — may be subject to formal change management. Means may be provided to support

- requests for and authorization of changes;
- version numbering and documentation;
- validation of changes; and
- audit tracking.

Change management may also include restrictions and checks necessary to maintain the integrity of the configuration. For example, it may be necessary to prevent a recipe creator from modifying a procedural element in use by an active recipe.

#### **6.1.2.6 Reference tracking**

Historical tracking of information references — for example, which definitions are used within which others or which served as the basis for others — can be important in analysis of production performance and in demonstrating compliance with production guidelines. This function can also provide a means to attach written comments about the changes, to assist in subsequent interpretation.

### **6.1.3 Process and control engineering**

In order for required processing functions to be properly carried out in a batch manufacturing environment, the equipment structure needed, the process functionality, and the exception handling for that equipment have to be fully developed. This requires a coordinated engineering effort that continues from initial definition through the life of the batch processing facility. This section describes the process and control engineering needed for the design of the controls needed to support the recipe hierarchy, the definition of equipment capability, and the development of the functionality required in the procedures to produce a batch.

Process and control engineering is needed at the general and site recipe levels to describe procedures, process stages, process operations, and process actions and at the master recipe level to describe recipe procedures, recipe unit procedures, recipe operations, and recipe phases.

The precise definition of appropriate procedural elements and equipment entities is an iterative process. The dual work process is illustrated in Figure 20. Considerations affecting one decision process also affect the other. Processing considerations are the primary input to the definition (or selection) of procedural elements that will characterize functionality for associated equipment entities. Since the functionality defined will be affected by the equipment used, equipment considerations must be a secondary input. In the same way, equipment considerations form the primary input and processing considerations the secondary input when making the definition (or selection) of equipment entities.

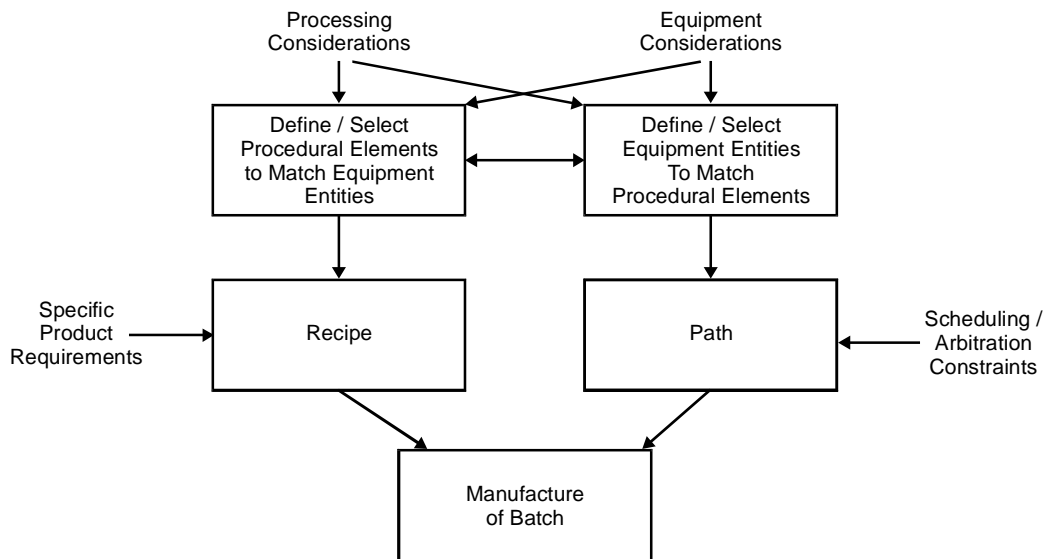

**Figure 20 — Simultaneous definition/selection of procedural elements and equipment entities**

Recipes can be constructed using these procedural elements and specific product information. The equipment entities are arranged into a path that is determined by scheduling and taking into account arbitration constraints. The combination of the results of these activities provides a framework within which a batch of material can be manufactured.

Process and control engineering also includes the development and revision of the equipment phases corresponding to the recipe phases that are used to define the recipe. As far as possible, recipe and equipment phases should be defined such that any reasonable functionality of a unit can be expressed in terms of these phases. They should generally not be tailored to a set of known recipes. Then, new recipes can in most cases be written by using existing recipe phases that reference existing equipment phases. The development and revision of recipe and equipment phases is an ongoing activity that provides ongoing support to the batch manufacturing facilities. This activity is the result of the ongoing drive for continuous improvement and the periodic addition of new process technology.

## 6.2 Recipe management

Recipe Management is made up of the control functions that create, store, and maintain general, site, and master recipes. The overall output of this control activity is a master recipe that is made available to Process Management, which uses it to create a control recipe.

Recipe Management will be discussed in terms of managing the three levels of recipes and defining the procedural elements used in the recipe procedures (see [Figure 21](#)).

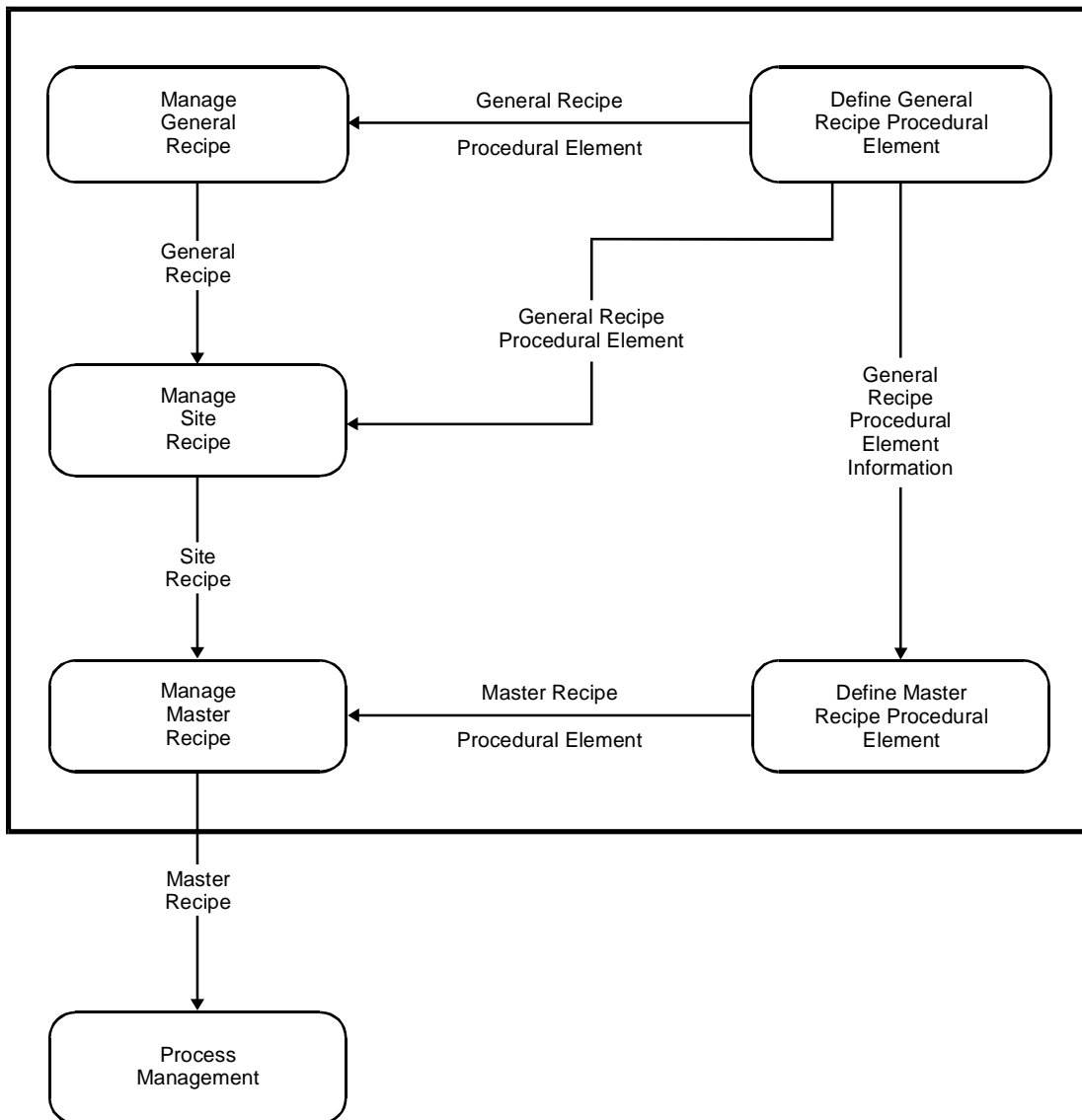

**Figure 21 — Recipe management**

### 6.2.1 Manage general recipes

*Manage general recipes* is the control function by which general recipes are created, maintained and stored. The specific processing requirements furnished by the process development activity for the product being considered serve as the basis for the general recipe.

In connection with the definition of the individual general recipe, the following capabilities may be required:

- Selecting and combining procedural elements to create a general recipe procedure
- Incorporating formula information
- Specifying equipment requirements and other information
- Maintaining the general recipe
- Managing changes to general recipes

### 6.2.2 Define general recipe procedural elements

The *define general recipe procedural elements* control function creates, maintains and makes available for subsequent use, the procedural elements that are used as building blocks in general recipe and site recipe procedures.

The procedural elements defined by this control function may be process actions, process operations, process stages, and/or an entire general recipe procedure. Not all levels of procedural elements need to be defined.

This control function defines general recipe procedural elements based on the processing strategies required by the different products and described by process development. This information is then made available to the *define master recipe procedural elements* control function. In this way, the process intent of the general recipe procedural elements may be known at the master recipe level. The strategies have to be interpreted and transformed into procedural elements that enable the flexible and modular construction of general recipes. The broader the range of products that can utilize these modular process activity descriptions, the easier it is to create a general recipe. More importantly, modular process actions, process operations, process stages, and/or complete procedures that are frequently reused tend to make recipe transformations at lower levels much easier to accomplish and recipes more consistent.

This procedural element information is then made available to the *define master recipe procedural elements* control function. In this way, the process intent of the general recipe procedural elements may be known at the master recipe level.

In connection with the definition of the individual general recipe procedural elements, the following capabilities may be required:

- Naming the individual procedural elements
- Specifying parameter variables
- Describing the intended processing functionality
- Combining lower level procedural elements and specifying the sequence of execution
- Creating, modifying, and archiving general recipe procedural elements
- Maintaining an inventory of procedural elements available
- Managing changes to procedural elements

### 6.2.3 Manage site recipes

Manage site recipes is the control function by which site recipes are created, maintained and stored. A site recipe is created by combining the information of the appropriate general recipe with site specific information. If additional or alternate procedural elements are required, only those defined under the *define general recipe procedural elements* control function are used.

### 6.2.4 Manage master recipes

*Manage master recipes* is the control function by which master recipes are created, maintained and stored. Master recipes are defined based on the specific processing requirements for the product in question. These specific processing requirements may be expressed in a general or site recipe.

The transformation of the site recipe into a master recipe may be a complex task. The creation of a procedure, based on predefined procedural elements, must match the intent of the site recipe procedure. Transformation (or creation) of the content of the formula follows the same general logic that is used to map process actions to recipe phases. The batch size is fixed, or the range

of batch sizes permissible for the recipe is established, if there are constraints on the degree of scalability. Formula information is adjusted accordingly. The equipment requirements are transformed into requirements that can be verified against the actual target equipment.

In connection with the definition of the individual master recipe, the following capabilities may be required:

- Selecting and combining procedural elements to create a master recipe procedure
- Incorporating formula information
- Specifying equipment requirements and other information
- Creating, modifying, and archiving master recipes and maintaining the recipe headers
- Maintaining an inventory of master recipes
- Managing changes to master recipes

### **6.2.5 Define master recipe procedural elements**

The *define master recipe procedural elements* control function creates, maintains and makes available for subsequent use, the procedural elements used in master recipe procedures. These become the building blocks of the master recipe procedure.

The master recipe procedural elements must reflect the processing capabilities required by master recipes. If these are generated from general and site recipes, then process stages, process operations, and process actions will map into unit procedures, operations, and phases. This control function defines the relationship between process actions and phases, between process operations and operations, and between process stages and unit procedures. It also defines the general scope of procedures, unit procedures, operations, and phases to allow maximum consistent use of pre-defined procedural elements across the range of products to be made in the facility.

The master recipe procedural elements must, at least at the recipe phase level, be able to reference equipment procedural elements when the derived control recipe is executed. A close coordination with the engineering of the equipment procedural elements must therefore take place, ensuring that the recipe procedural elements adequately reflect the control capabilities of the target equipment. If required, any new functionality is made available through creation of new procedural elements, along with associated control and equipment modifications ([see 6.1.3](#)).

In addition to providing the building blocks for the master recipe procedure, this control function may also define constraints on the configuration of master recipes, such as rules on the allowable order of recipe phases and limitations in the recipe creator's right to use recipe phases as building blocks. The determination of such constraints must be made based on many factors, such as safety, complexity of the recipe creator's task, required flexibility, and validation of individual procedural elements.

In connection with the definition of the individual procedural elements, the following capabilities may be required:

- Naming of the individual procedural elements
- Specifying parameter variables
- Describing the intended processing functionality
- Combining lower level procedural elements and specification of the sequence of execution

- Creating, modifying, and archiving master recipe procedural elements
- Maintaining an inventory of procedural elements available
- Managing changes to procedural elements

### 6.3 Production planning and scheduling

Production Planning and Scheduling is a high level control activity on a peer level with Recipe Management and Production Information Management. It is the decision process associated with producing a batch schedule that is provided to Process Management. Although several control functions would need to be collected together to make up this control activity, most of those control functions are outside the scope of this standard. This section will consider only one of these control functions: *Develop batch schedules*.

The *develop batch schedules* control function accepts inputs from sources such as other types of schedules, master recipes, and resource databases, and, based upon a scheduling algorithm (automated or manual), develops a batch schedule (see 5.4 for a list of typical information in a batch schedule).

The following capability is typically included in this control function:

- Developing a batch schedule based on information from the appropriate source and some scheduling algorithm
- Developing a revised batch schedule on demand based on significant changes in *batch progress and process cell status information* provided by Process Management
- Allowing for manual intervention into the scheduling process
- Determining the availability of resources as an input into the scheduling process
- Providing a procedure or method for batch sizing along with a means to organize the production of batches
- Determining the feasibility of the schedule based on the target equipment

### 6.4 Production information management

Production Information Management is a high level control activity on a peer level with Recipe Management and Production Planning and Scheduling. It is the control activity that is involved in collecting, storing, processing, and reporting production information.

The non-batch-related use of production information is not dealt with in this section, but in actual applications the management of batch-related information and non-batch-related information may very well be integral. Both batch-related and non-batch-related information may be used as input to higher-level control functions such as the generation of production reports to management. These activities will not be modeled in this standard.

Although several control functions would need to be collected together to make up this control activity, most of those control functions are outside the scope of this standard. This section will consider only one of these control functions: *Manage batch history*.

Batch history is a collection of data related to one batch. It may be organized in one or more files or tables per batch, or it may be present as a part of a database and retrievable via key fields, etc.

Batch history is built up of entries. An entry is a portion of information on the batch representing one value or a set of values describing one event, logged into the batch history in one action.

*Manage batch history* is the control function that typically includes the following capabilities:

- Receiving and storing information from other parts of the overall batch control application on batches
- Manipulating historical data
- Producing batch reports

The *manage batch history* control function is performed regardless of the equipment used or when a batch is produced. For example, lab data often may be added after the execution of the batch.

#### **6.4.1 Receiving and storing batch history information**

The entering of data from the outside into batch history is initiated from Process Management, Unit Supervision, and Process Control.

##### **6.4.1.1 General collection and storage guidelines**

All of the data for the batch history should be collected and stored in a way that includes or gives simple access to

- batch identification;
- absolute time stamp (Real time);
- identification of procedural elements with which the data is associated;
- time relative to the start or end of a batch or of the execution of a procedural element;
- equipment-independent entry identification;
- equipment utilized.

Adequate storage capacity is needed for the required number of batch histories. This should include sufficient capacity to store the batch histories of all running batches, and for finalized batches until appropriate actions have been taken (reports printed, long term backup or whatever action is specified).

To the extent that the storage time requirement exceeds the storage capacity of *manage batch history*, the capability must exist to export the batch histories onto long-term storage media or external systems. It must be possible to retrieve these batch histories for further extraction of data.

Reports or displays on the batch archive (number of batches in archive, amount of data, status [finalized, printed, archived in long term archive, etc.]).

##### **6.4.1.2 Reliability of batch history entries**

The requirements for reliability will vary from application to application and between the different entry types. In the following, a number of issues of reliability are described. For each type of entry, the appropriate level of reliability must be selected to match the needs of the individual application. Reliability issues include

- access control: control of access to the data-gathering system, including the configuration and the actual data collected;

— audit trail: identification of all manipulation that happened with each individual piece of information — including identification of the person or controls involved, the time and, in some cases, an explanation;

— logging reliability: specification of the required reliability of logging. Three levels may be distinguished:

a) Nice to have — no specific action in case of failure. Examples include data for optimization, equipment reliability statistics, etc.;

b) Limited holes acceptable if the failure is indicated in the batch history (logging absent from . . . to . . .);

c) Critical — data must be available. If it is missing, then backup procedures must be possible (electronic or manual backup, possibility of reconstruction, etc.).

The importance of exact logging of the latter type of information may be equivalent to the achieved product quality, either for financial reasons (accounting) or for product safety/responsibility reasons. Therefore the receiving function must be capable of providing feedback information on the general status of the receiving function (as well as specific confirmation feedback for each entry to the control activity that performs the logging) enabling them to perform buffering, redundancy or reintegration activities or, if required and allowed, to hold up the process.

— level of detail: This level should be well defined in the recipe, or it should be related to the process cell or parts of the process cell. It must be possible to see if an entry is absent because the corresponding event did not occur or because it is below the selected level of detail.

— logging of actual historic information: Batch history entries should, to the largest possible extent, reflect the actual physical/chemical events that influence the batch, not only what was anticipated in the recipe. That means that the character and amount of data logged will vary due to the variations in batch production.

— long-term consistency: The extent to which the interpretation of batch data relies on information outside of the batch history, such as cross reference lists between actual tags and batch entry tags or names of variables, should be well described. Such information should be stable in the long term. If changes or modifications do occur, then the versions that were relevant at the time of processing should be stored for use in data retrieval.

— speed of collection: Speed of collection should be considered a critical factor. In order to analyze the reasons for any abnormal conditions, it is important that the system be capable of recording the events and actions in the precise order in which they occurred.

### **6.4.1.3 Batch and material tracing**

The collection of batch histories can support batch and material tracing if it has a complete overview of the batches, including the equipment utilized and the identification of raw materials.

Batch history provides backwards tracing if a certain end product batch history can be traced back to all involved processes, equipment, and ingredients (and to the involved processes, equipment, and ingredients of these ingredients). Forward tracing is available if the consequences of a certain event or the usage of a certain raw material can be traced to all end products affected.



#### 6.4.1.4 Logging from process management

Process Management logging should include information associated with initiating and routing the batch, and the equipment-independent information associated with the batch. This includes

- master recipe: the master recipe from which the control recipe was derived — either in copy or by reference. In case of reference, the master recipe should be maintained unchanged as long as the reference may be called.
- Process Management events and control recipe information: information on any changes to and the execution of the control recipe. This includes information such as equipment allocation and start times for batches and unit procedures.
- operator comments: narrative descriptions or comments based on the operators' observations of the batch processing. This information entry should be capable of being recorded with the operator's identification.

#### 6.4.1.5 Logging from unit supervision and process control

This data could be dedicated to a single batch or to several batches, such as data from shared resources, utility systems, etc. In the latter case the data should be available to all the required batch histories. This includes:

- continuous data: Continuous data is defined as process data that is collected independent of specific events within the batch, with the purpose of giving an accurate history of that measurement.
- pre-specified batch data: data that is specified to be logged during execution of the control recipe. The specification of this data may come from the recipe or be pre-configured.

This would include such things as total feed to a reactor or mixing time.

- predictable events: events that are expected to occur, such as start and stop times of procedural elements.
- unpredictable events: Unpredictable event data is defined as a single point entry based on an unpredictable process or physical condition within the batch. This includes such items as process alarms, equipment failures or other upset conditions. In the case of process alarms, the historical data may include the following:
  - a) Time of activation
  - b) Time of acknowledgment
  - c) Time of disappearance of the alarm condition
  - d) Alarm limit
  - e) Maximum deviation while the alarm is active
  - f) Trending information while the alarm is active
- operator interventions: any operator intervention that may affect the processing of the batch. The operator intervention typically is logged with the following information:
  - a) Intervention type
  - b) Operator ID

#### 6.4.1.6 Late entries

Late entry data is data entered after execution of the part of the control recipe procedure to which it is related, or after production of the batch. This is typically data that is related to off-line measurements or analyses. *Manage batch history* includes the logging of such entries, including establishing the link to the associated batch events (like sampling). The following data may be associated with late entries:

- Measured value(s)
- Operator ID
- Lab technician ID
- Time of entry
- Time of sample

#### 6.4.2 Manipulating historical data

The following functions are typical:

- Data manipulation: altering (if legal) or supplementing archived batch data.
- Calculations: perform calculations on batch data creating new batch data related to one batch.
- Data reduction: data reduction on batch history information that is especially relevant with trend information. Loss of data in connection with data reduction should be well defined and related to the dynamics of the data, as well as the requirements of information based on this data.
- Batch tracking information: establishing or maintaining links between batch histories corresponding to the physical movements of the batches, ranging from the use of one batch as raw material to another, to the splitting or combining of batch histories due to splitting or combining of batches.

#### 6.4.3 Producing batch reports

In this section any export of data — electronically or on paper — is designated a report.

A batch report is, in general, made on a specific request. Such a request must be possible without knowledge of equipment and time of production. This is the case when

- the batch ID is used as entry key to access the data, not a piece of equipment;
- timing is relative to identified batch events (start of batch, start of operation, etc.);
- entries are identified in generic, batch-related terms and not in equipment-specific tags.

##### 6.4.3.1 Recipients of batch reports

Batch history data may be retrieved on request for a number of reasons:

- Production management: production overview summaries, consumption of raw materials and other resources, lot and batch tracking information
- Recipe management: recipe optimization information, comparison between recipe data and actual values, analysis of correlation across several batches, and comparison of trend information

- Process management: history of current batches and comparisons with old batches for operator display and process control optimization
- External systems:
  - a) quality control: statistical process control, compliance with product specifications, GMP (Good Manufacturing Practice) documentation
  - b) maintenance: alarms, equipment usage documentation
  - c) financial: raw material consumption, yields, produced quantities, etc.
  - d) customer support: product documentation
- Internally within *manage batch history*: Process Management may include functions to perform the queries mentioned above and the ability to export or print them on request, at regular intervals, or after each batch.

#### 6.4.3.2 Elements of batch reports

Some of the possible elements of a batch report include

- report header: This header contains information on the report type, batch or batches displayed in the report, descriptive text, etc.
- single elements: These data elements are displayed somewhere on the paper/screen.
- event lists: These are chronological lists of event-type entries with associated data. For example, this might include a list of alarms or a list of operator interventions.
- merging of entries in event lists: Entries with different tags and of different types may be merged into the same list.
- selection of entries into lists: Entries may be selected according to different criteria before entering lists. For example, the entries may include only high priority alarms.
- trends: These displays show one or more values on the same time axis.
  - a) single batch trend: These are trends that display data from one batch or a portion of a batch. They may display several values with individual time axis. The display may be in relative or absolute time.
  - b) multi-batch trend: These are trends that compare values from several batches in one trend display. They must be with relative time-axis. Some variables may be normalized to a standard amount.
  - c) event-marking in trends: Events may be introduced in the trend display by "ticks" on trends or other indications. The tick should refer to a specific event-type entry.
- time-series: These are displays of a time-series of one or more entries in a table-like fashion. The time-deadband, which is how close in time entries with different tags have to be in order to be displayed on the same line, must be specified in time series displays.
- interpolation: Rules for interpolation of data have to be established if data with different entry-times have to be displayed on one line or if the data are used in calculations.

## 6.5 Process management

Process Management is the collection of control functions that manages all batches and resources within a process cell. Within this control activity, control recipes are created from master recipes, each batch is defined as an entity, individual batches are initiated and supervised, resources within the process cell are managed to resolve conflicts for their use and process cell and batch data are collected. Process Management interfaces with Unit Supervision, Recipe Management, Production Planning and Scheduling, and Production Information Management (see Figure 22).

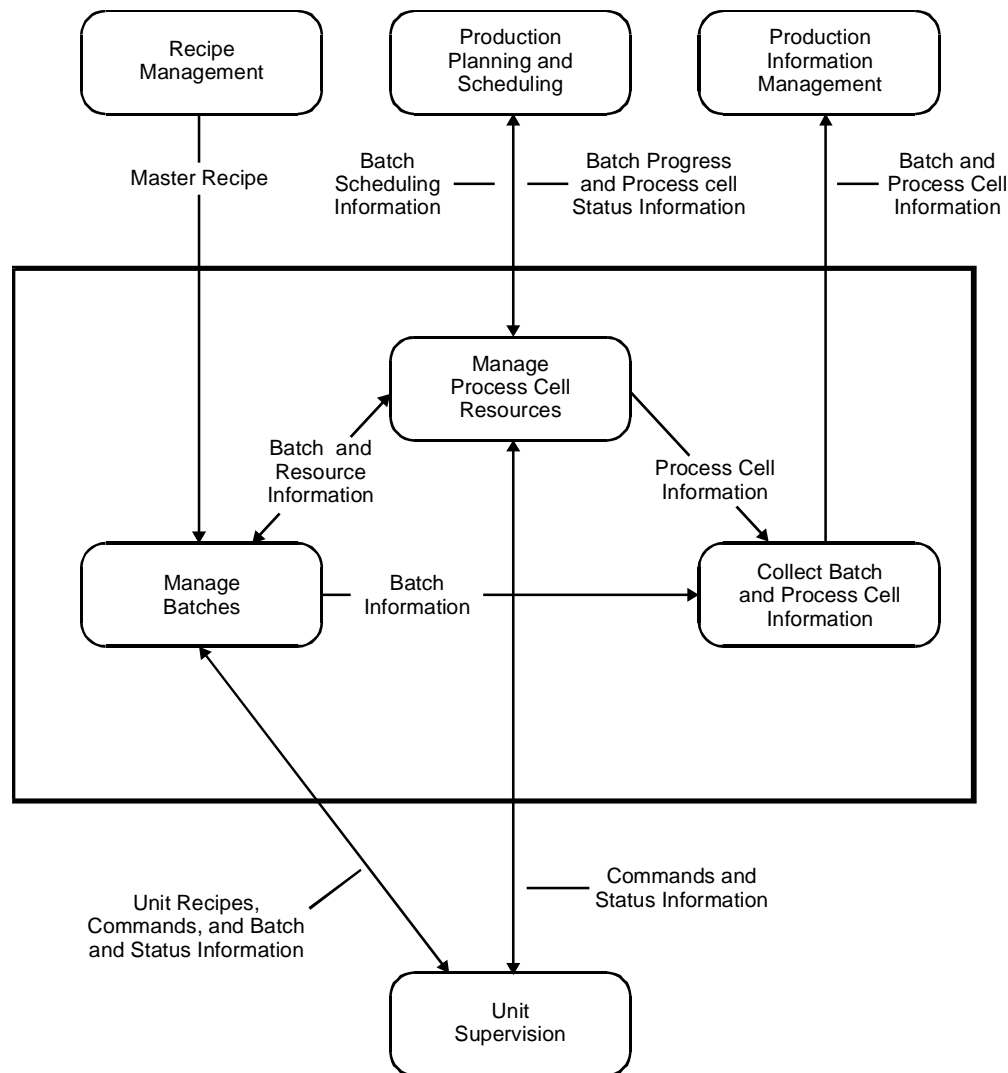

**Figure 22 — Process management**

At the process cell level, there are often multiple batches and multiple units, and each unit may be carrying out a unit procedure for a different batch. The progression of the procedure for each batch and the utilization of the individual pieces of equipment has to be coordinated based on information derived from the control recipe, scheduling information, and status of equipment and other common resources.

The domain of Process Management is the process cell. The successful execution of a control recipe makes a batch, and Process Management is finished with the batch when the control recipe procedure is complete. The batch that has been produced does not have to be a final product. It may take several control recipes running in the same process cell or in different process cells and/or sites to make the finished product(s). When a batch leaves the process cell, it is no longer the responsibility of Process Management associated with that process cell in terms of identification, batch tracking, etc.

Process Management can be discussed in terms of the following three control functions (see Figure 22):

- Manage batches
- Manage process cell resources
- Collect batch and process cell information

### 6.5.1 Manage batches

This is the control function in which a control recipe is created from a copy of a master recipe, a batch is initiated based on the scheduling information and operator input, and the execution of the batch is supervised.

The following capability is typically included in this control function:

- Creating a control recipe from the master recipe, scheduling information, and input received from the operator. This may happen with widely varying lead times, such as at the instant needed in some situations and well in advance of the scheduled execution time in others. The control recipe may be created initially in its entirety, or it may be created incrementally as the information is needed.
- Assigning a unique batch identification (batch ID) to each batch and to the associated control recipe. A batch may be identified or named in many different ways, but at least one identification, referred to here as the batch ID, must be verified to be totally unique within the process cell at any given time. The batch ID may be provided by the operator, in the scheduling information, or from within Process Management, but uniqueness is typically verified before it is associated with a batch.
- Verifying the control recipe as it is created. Verifying consists of ensuring that the control recipe is complete and is executable on the selected set of units. This includes verifying that all procedural elements are available, that formula information is valid, and that necessary resources can be expected to be available when needed.
- Sizing the control recipe to meet the batch quantity needed based on the sizing rules in the master recipe and the quantity specified in the batch scheduling information. The recipe may include the range over which it may be scaled.
- Maintaining all the current control recipes within Process Management until the batches are completed.
- Assigning the start conditions as specified in the scheduling information and/or provided by the operator. Some batch start conditions that may be used, either individually or in some combination, include the following:
  - a) Start batch as soon as a unit becomes available
  - b) Start based on operator direction
  - c) Start when specific units are available

- d) Start based on the scheduled priority of the batch
  - Modifying any part of a control recipe that has not been executed. This may include the ability to modify the procedure, such as adding and deleting unit procedures, operations, and/or phases, or looping back to repeat unit procedures, operations, and/or phases that have previously been executed.
  - Requesting and releasing units and other equipment, changing their status to indicate use, and updating the *manage process cell resources* control function on the status of the batch.
  - Monitoring and controlling the executing control recipe(s) including the current status of the batch, such as what unit procedures have been executed, and what unit procedure is next.
  - Processing requests for state and mode changes to procedures, unit procedures, operations, and phases.
  - Allowing a control recipe to span multiple units in the same process cell, including distributing unit recipes to Unit Supervision in a timely manner.
  - Allowing a batch to be suspended, removed from the processing equipment (packaged for temporary storage), and therefore out of the control of Process Management, and later recalled to complete the batch processing.
  - Maintaining batch status information. The control recipe, including all modifications, should be logged as part of the batch history as it is executed or at least when the batch leaves the process cell.
  - Updating information on batches to the *collect batch and process cell information* control function.

### 6.5.2 Manage process cell resources

This is the control function in which process cell resources are managed by allocating and reserving units and other equipment, by arbitrating multiple requests for the same equipment, and by providing a mechanism for controlling unallocated equipment. Process cell resources also include the materials within the process cell. Process cell resource management must know which materials are in the process cell, their location, and their disposition.

An assignment of resources at the process cell or unit level (resource allocation) needs to be provided in order for Process Management to be able to assign the equipment or equipment options from the batch schedule. Some limited equipment reassignment and generation of a new resource allocation at the process cell or unit level may also be needed by the operator. This new resource allocation may be necessary because of such variables as a malfunction in equipment or availability of raw materials. Production Planning and Scheduling may require notification of this new resource allocation to allow for assessment of impact.

The following capabilities are typically included in this control function:

- Obtaining scheduling information from Production Planning and Scheduling and providing this information to the *manage batches* control function
- Allocating or reserving equipment as requested by the *manage batches* control function. Within a process cell, batches may move from unit to unit. In each unit a portion of the control recipe, corresponding to the unit procedure, is executed. The control of what equipment to allocate to the different batches, and when transfers can take place may

require control at the process cell level. Some examples of how this allocation may be done are

- a) according to a batch schedule designating each individual unit allocation; or
  - b) according to a strategy defined at the process cell level combining the equipment requirements of the control recipe and the availability and capabilities of equipment.
- Arbitrating, as required, multiple requests for reservation or allocation of the same equipment. The rules for arbitration may be simple or complex, depending on the application. Examples of arbitration rule sets include the following:
- a) Order of request (FIFO)
  - b) Timed requests (such as by reserving the equipment)
  - c) Priority of batch
  - d) Maximizing equipment utilization (such as by minimizing cleaning requirements, minimizing energy consumption, or maximizing throughput)
  - e) Operator judgment
- Managing unallocated equipment within the process cell
- Receiving status information sent by Unit Supervision and/or status information sent by Process Control related to unallocated equipment within the process cell
- Updating information on all process cell resources to the collect batch and process cell information control function
- Updating Production Planning and Scheduling with batch progress information, such as
- a) batch ID;
  - b) batch state change events;
  - c) actual quantities of raw materials, products, and utilities;
  - d) equipment assignments; and
  - e) projected and actual allocation and de-allocation times of process cell resources.

### **6.5.3 Collect batch and process cell information**

This is the control function in which information is collected about Process Management events, both batch and equipment oriented, from the *manage batches* and *manage process cell resources* control functions. This information is made available to Production Information Management.

Examples of the types of information collected include the following:

- Mode and state changes
- Incremental copies of control recipes as each portion is finished
- Time that commands were sent to Unit Supervision and Process Control
- Time that unit recipes were sent to Unit Supervision
- Delays encountered due to lack of equipment availability

- Time of allocation, reservation and release of each process cell resource
- Requests and result of requests for equipment allocation or reservation which required arbitration
- Status changes in unallocated equipment
- Operator intervention

## 6.6 Unit supervision

Unit Supervision is the control activity that ties the recipe to equipment control via Process Control (see Figure 23). This control activity interfaces with Process Management, Process Control, and Production Information Management. There are three main control functions within this control activity that are discussed in this section. They include acquiring and executing procedural elements, managing unit resources, and collecting batch and unit information.

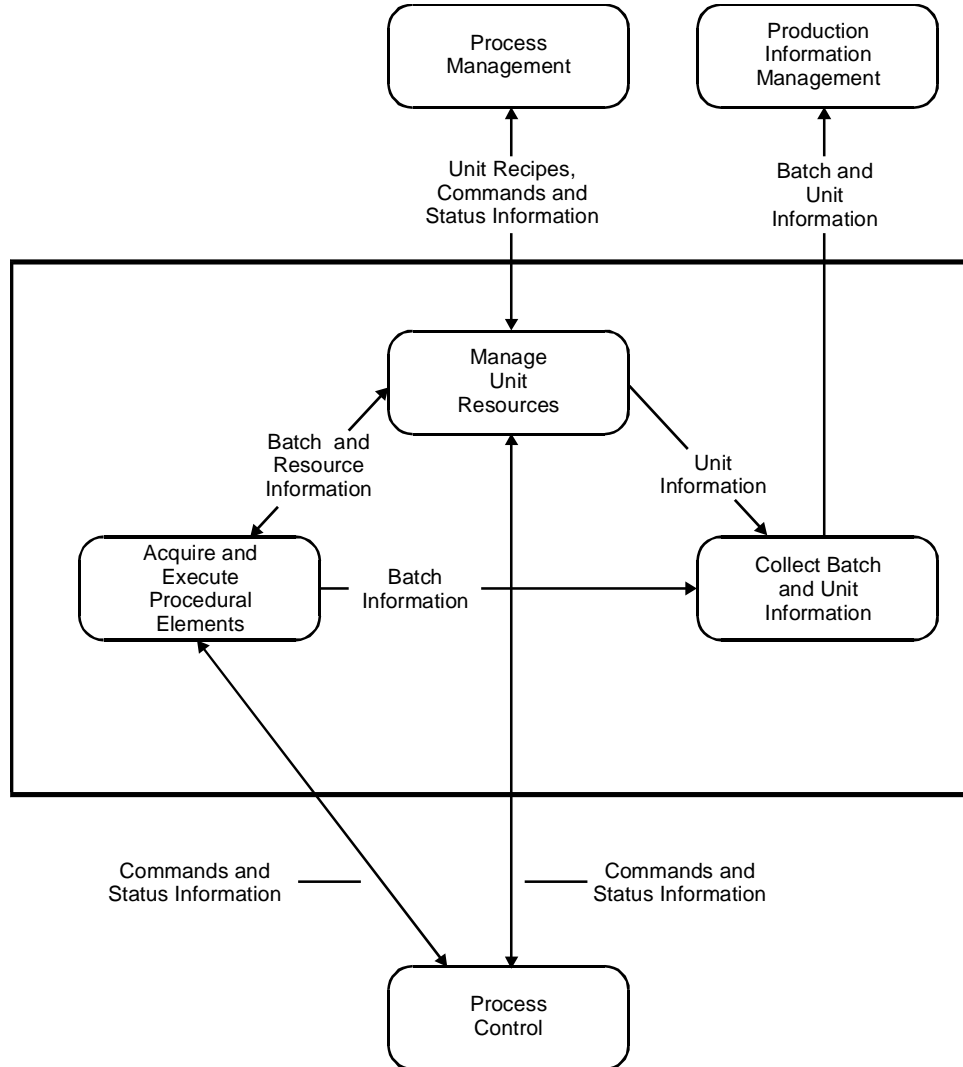

**Figure 23 — Unit supervision**



### 6.6.1 Acquire and execute procedural elements

Process Management supplies the unit recipe that will be executed within the unit and also supplies other batch information required to manufacture the batch.

Unit Supervision has to be able to determine from the unit recipe the procedural logic to be run, the appropriate parameters, the equipment entities to be utilized, and other pertinent information, such as the name of the product, equipment restrictions, and the batch number.

*Acquire and execute procedural elements* includes the execution of unit procedures. If the unit procedure is part of equipment control in the unit, this control function associates the recipe unit procedure, including the parameters, with the equipment unit procedure.

*Acquire and execute procedural elements* includes the execution of operations. If the operation is part of equipment control in the unit, this control function associates the recipe operation, including the parameters, with the equipment operation. The initiation and parameterization of phases is part of the execution of an operation.

*Acquire and execute procedural elements* includes the initiation and/or execution of phases. If the phase is part of equipment control in the unit, this control function associates the recipe phase, including the parameters, with the equipment phase. If the phase is part of equipment control in an equipment module, this control function must initiate and parameterize the equipment phase.

The following capabilities are typically included in this control function:

- Determining which procedural elements are to be executed
- Verifying that the procedural elements exist
- Executing unit procedures, operations, and phases
- Associating recipe procedural elements with equipment procedural elements
- Initiating and parameterizing equipment phases

### 6.6.2 Manage unit resources

This control function includes the management of resources that are part of the unit, management of resources that might have been acquired and have not yet been released, initiation of requests for resources that are not currently part of the unit, requests for services from other units, and providing services to another unit.

During the execution of a recipe, it may be necessary to acquire shared-use and/or exclusive-use resources that will subsequently be released. Although units cannot acquire other units, they can request services from or provide services to another unit as long as the recipe has specified compatible procedural logic for both units. The phases or operations in the units can communicate to perform a coordinated function.

Unit-to-unit coordination may be used to enable functions such as material transfers between units.

The following capabilities are typically included in this control function:

- Issuing requests to, reacting on feedback from, and interfacing with arbitration functions related to the equipment in question
- Ensuring appropriate propagation of unit and procedural element modes and states
- Enabling collection of production information relevant to the batch from external equipment

### 6.6.3 Collect batch and unit information

The *Collect Batch and Unit Information* control function makes information available to Production Information Management about Unit Supervision events, both batch and equipment oriented.

Data collection may be conditional. That is, certain data might not always be collected or might be sampled at a different time interval, depending upon information received from another control function, such as from parameters passed to the equipment phase.

Examples of the types of information collected include the following:

- Mode and state changes
- Timing of commands sent to Process Control
- Timing of the execution of the unit recipe procedure events
- Timing and sequence of allocation, reservation, and release of equipment entities acquired by the unit
- Status changes in unit equipment
- Values derived during execution of the unit recipe

## 6.7 Process control

This control activity encompasses procedural and basic control, including sequential, regulatory, and discrete control, in addition to gathering and displaying data. This control activity will be distributed among several equipment entities, including units, equipment modules and control modules. It interfaces with Production Information Management, Unit Supervision, and Personnel and Environmental Protection.

Process Control can be discussed in terms of three control functions: execute equipment phases, execute basic control, and collect data (see [Figure 24](#)).

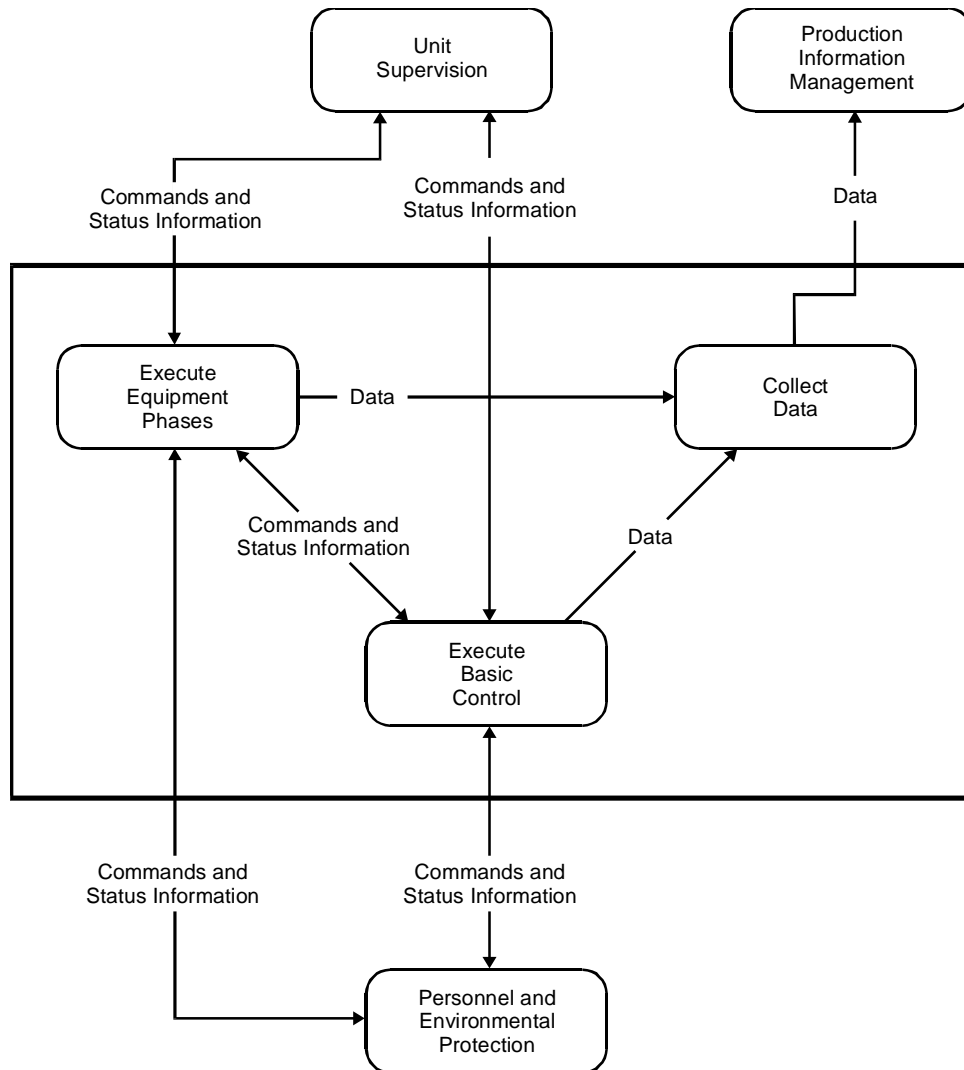

**Figure 24 — Process control**

### 6.7.1 Execute equipment phases

This is the control function in which equipment entities receive commands to perform procedural control described by an equipment phase. This control function is initialized by the *Acquire and execute procedural element* control function in Unit Supervision (6.6.1). By definition, the equipment phase is configured as part of an equipment entity. However, parameter values may be necessary in order to execute the equipment phase. The *Execute equipment phase* control function interprets the phase initialization command and associates the necessary parameters with the equipment phase. Equipment phases may be commanded and parameterized before or during execution. Equipment entities capable of performing this control function are equipment modules and units.

This control function does not act directly on physical equipment. It influences the process only through the basic control in a control module.

This control function also includes the supervision of equipment phase modes and states. This includes

- the propagation of modes and states from/to any procedural element and/or equipment entity;
- the propagation of modes and states from the unit or equipment module executing the equipment phase; and
- manual intervention into the execution of the equipment phase.

### **6.7.2 Execute basic control**

Executing basic control is a control function that causes changes in equipment and process states by sending commands to actuators and other control modules. Commands to basic control may come from the execution of an equipment phase or from another control function, such as a manual command from an operator. Basic control uses input from sensors and other control functions in order to execute its function. The execution of this control function may also result in process, equipment, and other status information being provided to high level control functions. Some other basic control functions that may be included are exception handling, calculations, and treatment of operator-entered information, etc.

However, this control function does not contain procedural control and is always configured as part of the equipment entity. This control function also includes the association of the necessary parameters with the appropriate basic control function. Equipment entities capable of performing this control function are control modules, equipment modules, and units.

This control function also includes the supervision of equipment entity modes and states. This includes

- the propagation of modes and states from/to any equipment entities and/or procedural elements; and
- manual intervention.

Where the equipment entity is a common resource, this control function may also be involved in the arbitration of conflicting requests and commands.

### **6.7.3 Collect Data**

In the *Collect Data* control function, data from sensors, derived values, and events that occur within the domain of Process Control are collected and stored in batch history. Data collection may be conditional. That is, certain data might not always be collected or might be sampled at a different time interval, depending upon information received from another control function, such as from parameters passed to the equipment phase.

## **6.8 Personnel and environmental protection**

The Personnel and Environmental Protection control activity provides safety for people and the environment. It is shown in the Control Activity Model in Figure 19 (see [Section 6.1.1](#)) below Process Control because no other control activity should intervene between Personnel and Environmental Protection, and the field hardware it is designed to operate with. Personnel and Environmental Protection is, by definition, separate from higher level control activities. It may map to more than one level of equipment entity if that level of organization or sophistication is required to provide adequate safety protection.

Personnel and environmental protection is included in the control activity model to emphasize the importance of these types of protection systems and to indicate the point in the model appropriate for insertion of a separate protection system of this type. A complete discussion of personnel and environmental protection, the classification of these types of systems, and the segregation of levels of interlocks within these systems is a topic of its own and beyond the scope of this standard. More information on this topic can be obtained from some of the standards and guidelines that are under development (see References 1, 2, 3, 4, and 5 in [Annex B](#)).



---

## Annex A — (normative) Model philosophy

---

A number of drawing formats have been used in this standard. Each of these drawing formats is discussed below.

The modeling formats discussed in this section provide a non-rigorous method of portraying information and relationships. They are not intended to recommend or imply an analysis methodology or to have the figures supersede the information described in the text.

- All Entity-Relationship (E-R) diagrams are shown using the format described in Figures A.1 and A.2. The description of the relationship will be shown in one direction only. Figure A.3 is an example.
- Entities are shown as rectangles in all drawings.
- Activities or functions are shown as rounded rectangles in all drawings. These drawings only show the explosion of one control activity per diagram. Lines between activities and between functions show information exchange. An example is Figure A.4.
- States are shown as ellipses in all drawings. Lines between states identify commands that cause the state changes. Figure A.5 is an example of a state transition diagram.
- Physical drawings use the ISA symbol standards, where applicable. Figure A.6 is an example.
- Nested drawings are only used where it is desirable to show a relationship between two different types of recipes. Figure A.7 is an example.

Basic Associations:

For each occurrence of A,  
there is one and only one  
occurrence of B.

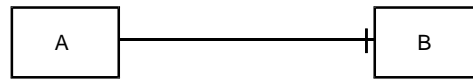

For each occurrence of A,  
there is zero or one  
occurrence of B.

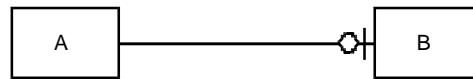

For each occurrence of A,  
there is one or more  
occurrences of B.

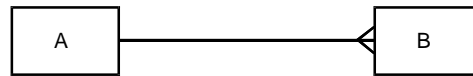

For each occurrence of A,  
there is zero, one, or  
more occurrences of B.

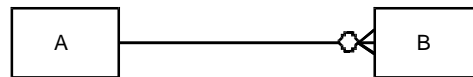

Looped Associations:

Any of the associations  
above may be used in a  
loop. Here, an occurrence  
of an entity is associated  
with one or more  
occurrences of entities  
of the same type.

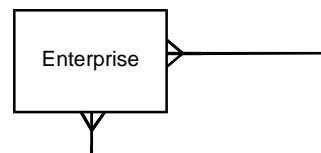

**Figure A.1 — Basic and looped associations in Entity-Relationship diagrams**



Labeled Associations:

A label is written  
next to one of the entities.

In this case, it reads:  
A consists of B.

In this case, it reads:  
A references B.

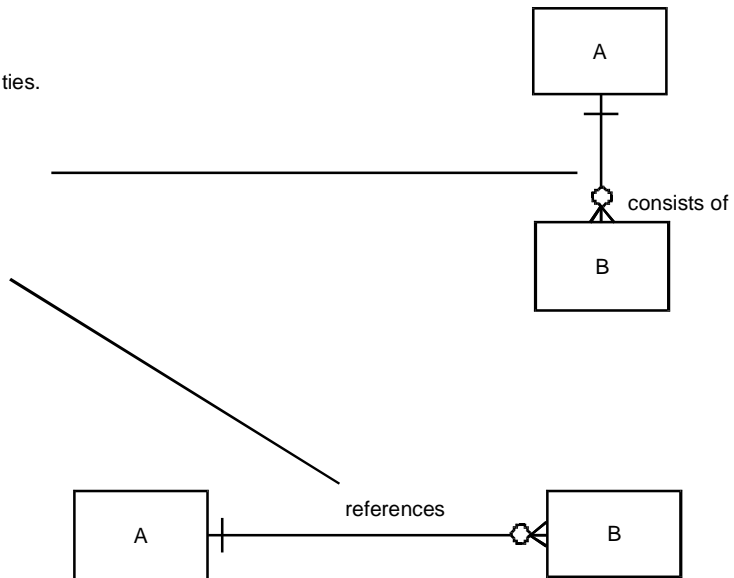

**Figure A.2 — Labeled associations in Entity-Relationship diagrams**

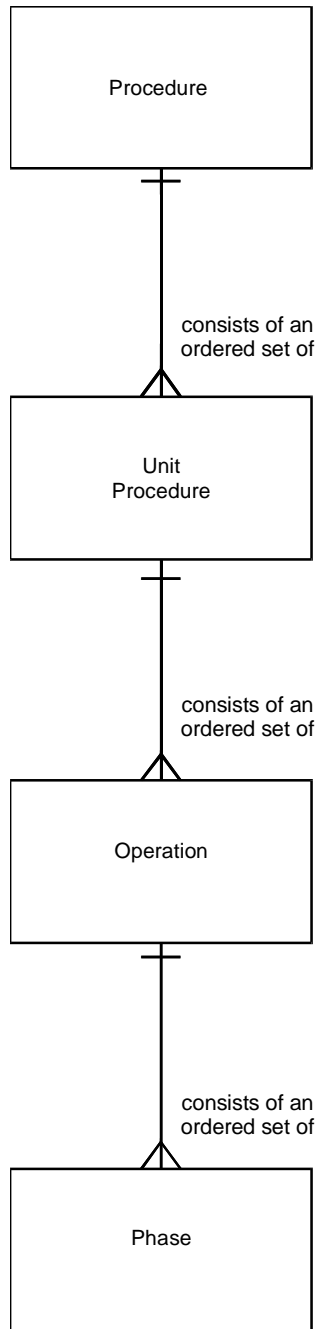

**Figure A.3 — Process model (Entity-Relationship diagram)**

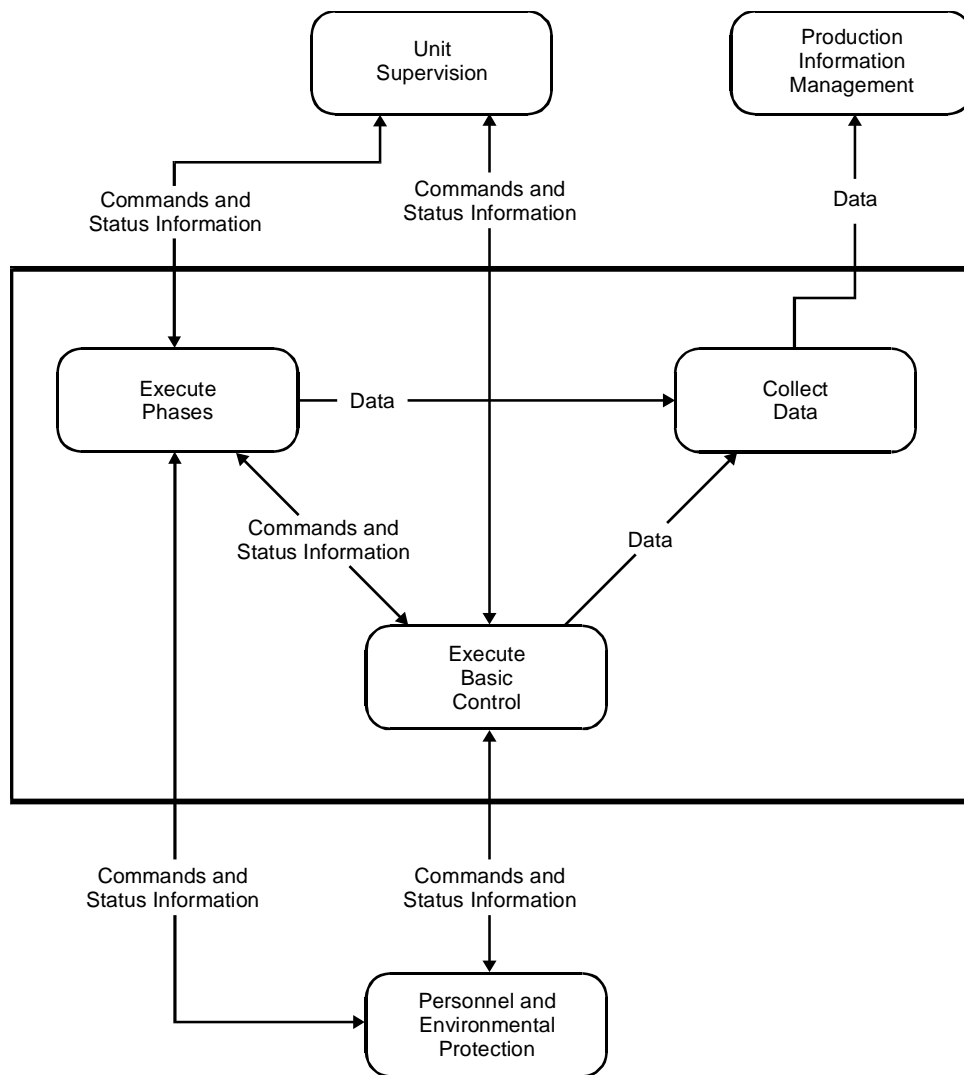

**Figure A.4 — Process control (control activity with breakdown into control functions)**

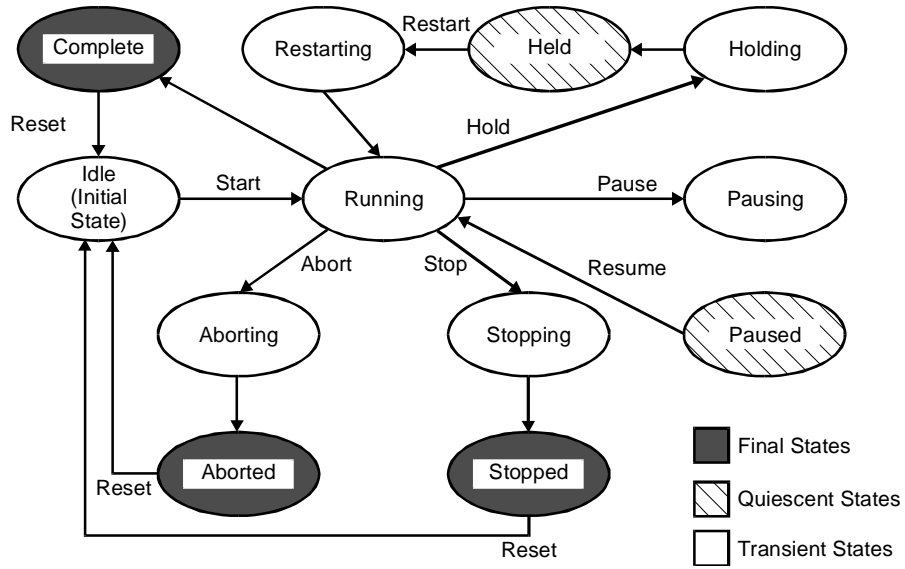

**Figure A.5 — State transition diagram**

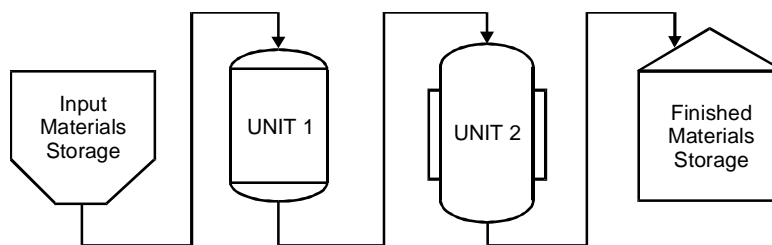

**Figure A.6 — Single-path structure (physical drawing)**

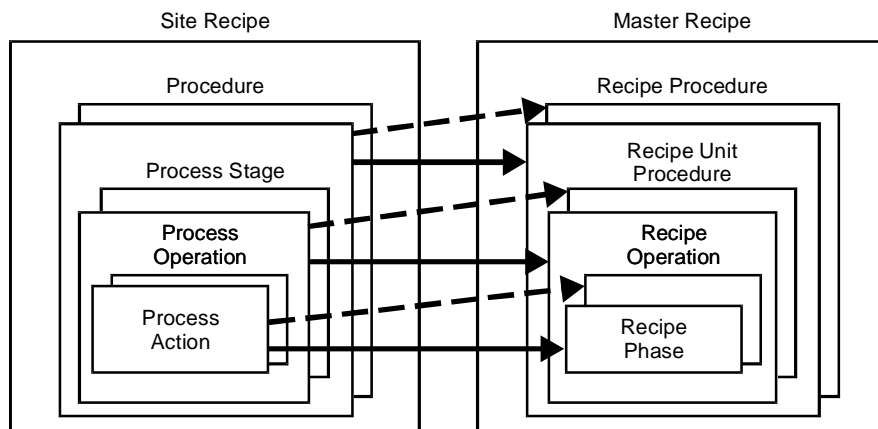

**Figure A.7 — Site recipe procedure to master recipe procedure relationship (nesting model)**



---

## Annex B — (informative) Bibliography

---

1. ISA-dS84.01: Applications of Safety Instrumented Systems for the Process Industries, Instrument Society of America.
2. IEC SC65A/WG10, 65A (Secretariat) 122: Functional safety: safety-related systems. Part 1: General requirements, International Electrotechnical Commission.
3. IEC SC65A/WG9, 65A (Secretariat) 122: Functional safety: safety-related systems. Part 2: Requirements for Electrical/Electronic/Programmable electronic systems, International Electrotechnical Commission.
4. IEC SC65A/WG9, 65A (Secretariat) 122: Functional safety: safety-related systems. Part 3: Software requirements, International Electrotechnical Commission.
5. Guidelines for Safe Automation of Chemical Processes, Center for Chemical Process Safety, American Institute of Chemical Engineers, New York 1993.







---

---

---

---

Developing and promulgating technically sound consensus standards, recommended practices, and technical reports is one of ISA's primary goals. To achieve this goal the Standards and Practices Department relies on the technical expertise and efforts of volunteer committee members, chairmen, and reviewers.

ISA is an American National Standards Institute (ANSI) accredited organization. ISA administers United States Technical Advisory Groups (USTAGs) and provides secretariat support for International Electrotechnical Commission (IEC) and International Organization for Standardization (ISO) committees that develop process measurement and control standards. To obtain additional information on the Society's standards program, please write:

ISA  
Attn: Standards Department  
67 Alexander Drive  
P.O. Box 12277  
Research Triangle Park, NC 27709

---

---

---

---

ISBN: 1-55617-562-0